

# MK608UBAN Series

## High Capacity Direct Operated Pressure Reducing Valve

The MK608UBAN series are spring loaded, direct-operated, pressure reducing regulators. Their main function is to regulate the outlet (downstream) pressure. Available in ½ up to 2 inches (DN15 up to DN50) body sizes, the MK608UBAN can be supplied with a wide range of different end connections. The "bolted" flanged design provides flexibility to meet custom face to face dimensions as required (easy to install/suitable for old valves replacement). These regulators have a compact design and durable construction to sustain rugged use and their construction makes them easy to install and to maintain.



### FEATURES

- Flow to open design
- From 9 to 14 different CV's for each size to assure high accuracy in regulation
- Metal or Soft Seat
- Internal pressure sensing (external on request)
- Packingless construction (available only with internal pressure sensing)
- Wide range of actuators according to the requested regulation range
- Wide range of elastomeric diaphragms or in AISI 316
- Fully sealed construction available (suitable for dangerous medium; ATEX compliant)
- Balanced construction available for high pressure drops



**Jordan Valve a division of Richards Industries**  
3170 Wasson Road • Cincinnati, OH 45209  
513.533.5600 • 800.543.7311 • 513.871.0105 (f)  
info@richardsind.com • www.jordanvalve.com

**SPECIFICATIONS**

**Function:** Relief/ Backpressure/ Differential

**Line Sizes:** 1/2" up to 2" (DN15 - DN50)

**End Connections:**

- Threaded (F-NPT or GAS/ BS)
- Flanged (ANSI or PN)

**Seat:** Single

**Max Rating:** ANSI 600

**CV:** From 0.031 up to 35

**Body Material:**

- Carbon Steel
- Stainless Steel
- "Exotic" Materials

**Trim Material:**

- Stainless Steel (std)
- "Exotic" Materials

**Diaphragms:**

- Polychloroprene
- EPDM
- FKM
- Stainless Steel
- Other

**Max Inlet Pressure:** 754 psig (52 barg)

**Regulated Pressure Range:** 0.017 - 754 psig (0.0012 - 52 barg)

**Min/ Max Temperature:** -320.8°F/ 572°F (-196°C/ 300°C)

**Table 1 - Fluid Applications**

<b>Gas</b>	Air, inert gas, CO <sub>2</sub> , CO, hydrocarbons, O <sub>2</sub> , H <sub>2</sub> , F, NH <sub>3</sub> , firgorific gas.
<b>Steam/Vapour</b>	Water Steam, alcoholic vapours, organic vapours, sulphuric acid, refrigerating vapor
<b>Liquid</b>	Water, aqueous solutions, hydrocarbons, alcohol, lubricating oils, diathermic, oils, solvents, refrigerating fluids, acrylic compounds

**SPECIFICATIONS, CONT.**

**Table 2 - Capacities**

Nozzle	Body Size									
	1/2" (DN15)		3/4" (DN20)		1" (DN25)		1-1/2" (DN40)		2" (DN50)	
1	0.031 (0,027)	0.031 (0,027)	0.031 (0,027)	0.031 (0,027)	0.031 (0,027)	0.031 (0,027)	0.031 (0,027)	0.031 (0,027)	0.031 (0,027)	0.031 (0,027)
2	0.15 (0,13)	0.11 (0,10)	0.15 (0,13)	0.12 (0,10)	0.16 (0,14)	0.13 (0,11)	0.16 (0,14)	0.15 (0,13)	0.16 (0,14)	0.15 (0,13)
3	0.35 (0,30)	0.24 (0,21)	0.35 (0,30)	0.24 (0,21)	0.35 (0,30)	0.24 (0,21)	0.35 (0,30)	0.24 (0,21)	0.35 (0,30)	0.24 (0,21)
4	0.57 (0,49)	0.40 (0,35)	0.59 (0,51)	0.40 (0,35)	0.59 (0,51)	0.40 (0,35)	0.59 (0,51)	0.40 (0,35)	0.59 (0,51)	0.40 (0,35)
5	1.0 (0,87)	0.44 (0,38)	1.0 (0,87)	0.44 (0,38)	1.0 (0,87)	0.44 (0,38)	1.0 (0,87)	0.44 (0,38)	1.0 (0,87)	0.44 (0,38)
6	1.2 (1,0)	0.67 (0,58)	1.2 (1,0)	0.67 (0,58)	1.2 (1,0)	0.67 (0,58)	1.2 (1,0)	0.67 (0,58)	1.2 (1,0)	0.67 (0,58)
8	2.1 (1,8)	1.2 (1,0)	2.1 (1,8)	1.3 (1,1)	2.2 (1,9)	1.4 (1,2)	2.3 (2,0)	1.4 (1,2)	2.3 (2,0)	1.4 (1,2)
10	3.0 (2,6)	1.7 (1,5)	3.1 (2,7)	1.7 (1,5)	3.1 (2,7)	1.7 (1,5)	3.3 (2,9)	1.9 (1,6)	3.5 (3,0)	1.9 (1,6)
12	4.3 (3,7)	2.0 (1,7)	4.3 (3,7)	2.0 (1,7)	4.4 (3,8)	2.0 (1,7)	4.7 (4,07)	2.0 (1,73)	4.7 (4,07)	2.0 (1,7)
14			5.5 (4,8)	2.4 (2,1)	5.5 (4,8)	2.4 (2,1)	6.0 (5,2)	2.4 (2,1)	6.0 (5,2)	2.4 (2,1)
16			5.9 (5,1)	2.7 (2,3)	6.1 (5,3)	2.7 (2,3)	6.6 (5,7)	2.7 (2,3)	7.9 (6,8)	2.7 (2,3)
18					7.5 (6,5)	3.0 (2,6)	8.2/ 8.0* (7,1/ 6,9*)	3.0 (2,6)	9.2/ 9.0* (8,0/ 7,8*)	3.0 (2,6)
20					8.2 (7,1)	3.5 (3,0)	10.4/ 9.8* (9,0/ 8,5*)	4.0 (3,5)	10.4/ 10.1* (9,0/ 8,7*)	4.0 (3,5)
22							12.8 / 12.5* (11,1/ 10,8*)	4.3 (3,7)	12.8 / 12.5* (11,1/ 10,8*)	4.3 (3,7)

Cv for all body sizes with **elastomer diaphragm**
 Cv (Kv) for all body sizes with **metal diaphragm**  
 \*Reduced Cv (Kv) for actuator 100

**Table 3 - Maximum Inlet Pressures Related to Temperature**

End Connection	Construction	Temperature			
		212°F (100°C)	392°F (200°C)	482°F (250°C)	572°F (300°C)
Flanged	CS	1566 psig (108 barg)	1566 psig (108 barg)	1566 psig (108 barg)	1566 psig (108 barg)
	Full CS				
	SS				
	Full SS	1088 psig (75 barg)	899 psig (62 barg)	841 psig (58 barg)	783 psig (54 barg)
	Full CS NACE	1262 psig (87 barg)	1262 psig (87 barg)	1262 psig (87 barg)	1262 psig (87 barg)
	SS NACE				
	Full SS NACE	899 psig (62 barg)	841 psig (58 barg)	812 psig (56 barg)	798 psig (55 barg)
Threaded	1/2" through 1"	3437 psig (237 barg)	2886 psig (199 barg)	2741 psig (189 barg)	2567 psig (177 barg)
	1 1/2"	1189 psig (82 barg)	986 psig (68 barg)	928 psig (64 barg)	870 psig (60 barg)

**SPECIFICATIONS, CONT.**

**Table 4 - Actuator Operating Ranges**

Actuator	Actuators spring ranges	Maximum Allowable Pressure
100	65.3 to 667.2 Psig (4,5 to 46,0 Barg)	754.2 Psig (52 Barg)
120	37.7 to 427.9 Psig (2,6 to 29,5 Barg)	478.6 Psig (33 Barg)
130	24.7 to 320.5 Psig (1,7 to 22,1 Barg)	362.6 Psig (25 Barg)
140	10.2 to 133.4 Psig (0,7 to 9,2 Barg)	145 Psig (10 Barg)
220	1.4 to 39.2 Psig (0,094 to 2,7 Barg)	43.5 Psig (3 Barg)
360	0.04 to 12.2 Psig (0,0025 to 0,84 Barg)	14.5 Psig (1 Barg)
515*	0.017 to 3.3 Psig (0,0012 to 0,23 Barg)	3.6 Psig (0,25 Barg)

\*For tank blanketing application.

**Table 5 - Material Combination**

Body				
	Carbon steel (AF1/AS1)	Full Carbon Steel (AF2/AS2)	316 SS (IF2/IS2)	Full 316 SS (IF3/IS3)
	-32°F ≤ T ≤ 392°F	-20°F ≤ T ≤ 482°F	-20°F ≤ T ≤ 482°F	-320°F ≤ T ≤ 482°F
	(0°C ≤ T ≤ 200°C)	(-29°C ≤ T ≤ 250°C)	(-29°C ≤ T ≤ 250°C)	(-196°C ≤ T ≤ 250°C)
Body	ASME SA-216 WCC	ASME SA-216 WCC	ASME SA-351 CF8M	ASME SA-351 CF8M
HP Insert	ASME SA-351 CF8M	ASME SA-351 CF8M	ASME SA-351 CF8M	ASME SA-351 CF8M
IN/OUT Flanges	ASME SA-216 WCC	ASME SA-216 WCC	ASME SA-216 WCC	ASME SA-216 WCC
Blindhead	ASTM A-350 LF2	ASTM A-350 LF2	ASTM A-479 316	ASTM A-479 316
Studs	ASTM SA-193 B7	ASTM SA-193 B7	EN ISO 3506-1 A4-70	EN ISO 3506-1 A4-70
Nuts	ASME SA-194 2H	ASME SA-194 2H	EN ISO 3506-2 A4-70	EN ISO 3506-2 A4-70
Trim				
Disc (standard)	See Table 7			
Plug	ASME SA-351 CF8M	ASME SA-351 CF8M	ASME SA-351 CF8M	ASME SA-351 CF8M
Guide	ASTM 17-4 PH	AST 17-4 PH	ASME A-479 304/Nitronic 60	ASME A-479 304/Nitronic 60
Actuator				
Spring case	ASME SA-278 35	ASME SA-216 WCC	ASME SA-216 WCC	ASME SA-351 CF8M
Actuator diaphragm case	ASME SA-216 WCC	ASME SA-216 WCC	ASME SA-351 CF8M	ASME SA-351 CF8M
Spring	ASTM A-401	ASTM A-401	ASTM A-401	ASTM A-313 316
Diaphragm	See Table 8			

**Note:** SS = Stainless Steel

**SPECIFICATIONS, CONT.**

**Table 6 - Temperature Range for Flat Gaskets**

Materials	Temperature Limits
Polytetrafluoroethylene (PTFE)	-328 to 482°F (-200 to 250°C)
No asbestos	-58 to 392°F (-50 to 200°C)
Graphite + AISI 316	-328 to 1022°F (-200 to 500°C)

**Table 7 - Temperature Range and Inlet Pressure Limits for for Disc Material**

Materials	Temperature Limits	Maximum Pressure
Fluoroelastomer (FKM-FPM)	-14 to 392°F (-10 to 200°C)	580psig (40barg)
Polytetrafluoroethylene (PTFE)	-328 to 482°F (-200° to 250°C)	2900psig (200barg)
Stainless Steel	-321 to 851°F (-196 to 455°C)	4060psig (280barg)

**Table 8 - Temperature Range for Diaphragms**

Materials	Temperature Limits
Chloroprene (CR)	-4 to 194°F (-20 to 90°C)
NBR	-13 to 194°F (-25 to 90°C)
HNBR	5 to 248°F (-15 to 20°C)
Fluorocarbon (FKM-FPM)	14 to 392°F (-10 to 200°C)
Ethylene-Propylene (EPDM)	-31 to 320°F (-35 to 160°C)
Tetrafluoroethylene/propylene (TFE/P)	41 to 392°F (5 to 200°C)
Silicone (VMQ)	-58 to 300°F (-50 to 150°C)
Fluorosilicone (FVMQ)	-58 to 300°F (-50 to 150°C)
Stainless Steel	-321 to 851°F (-196 to 455°C)

**SPECIFICATIONS, CONT.**

**Table 9 - Temperature Range for O-Rings**

Materials	Temperature Limits
Polytetrafluoroethylene (PTFE)	-328 to 482°F (-200 to 250°C)
Fluorocarbon (FKM-FPM)	14 to 392°F (-10 to 200°C)

**Table 10 - Temperature Range for Metal Parts**

Materials	Temperature Limits
Cast Iron	32 to 449.6°F (0 to 232°C)
Carbon Steel	-20 to 797°F (-29 to 452°C)
Stainless Steel	-321 to 851°F (-196 to 455°C)

**SPECIFICATIONS, CONT.**

**Table 11 - Spring Ranges**

Actuator	Spring	Spring Ranges			
		Minimum Set Pressure		Maximum Set Pressure	
		Name	psi	barg	psi
100	4BIS	65	4,5	126	8,7
	6	105	7,2	203	14,0
	7	151	10,4	314	21,6
	8	211	14,6	334	23,0
	9	319	22,0	502	34,6
	9BIS	397	27,4	550	37,9
	10	494	34,1	604	41,7
	10BIS	548	37,8	667	46,0
120	4BIS	37	2,6	59	4,1
	6	56	3,8	95	6,6
	7	77	5,3	147	10,1
	8	105	7,3	156	10,8
	9	156	10,8	235	16,2
	9BIS	193	13,3	258	17,8
	10	238	16,4	283	19,5
	10BIS	263	18,1	428	29,5
130	4BIS	25	1,7	44	3,0
	6	39	2,7	71	4,9
	7	55	3,8	110	7,6
	8	76	5,2	116	8,0
	9	113	7,8	175	12,1
	9BIS	141	9,7	192	13,2
	10	174	12,0	211	14,5
	10BIS	193	13,3	320	22,1
140	4BIS	10	0,7	19	1,3
	6	16	1,1	31	2,1
	7	23	1,6	47	3,3
	8	32	2,2	50	3,5
	9	48	3,3	75	5,2
	9BIS	60	4,1	83	5,7
	10	74	5,1	91	6,3
	10BIS	82	5,7	133	9,2
220	2bis	1.36	0,094	1.8	0,12
	3	1.54	0,106	3.0	0,20
	4	1.84	0,127	3.4	0,24
	4bis	2.1	0,144	5.4	0,37
	6	3.8	0,26	8.7	0,60
	7	5.8	0,40	13.4	0,93
	8	8.4	0,58	14.3	0,99
	9	13	0,9	21.5	1,5
	9bis	16	1,1	23.6	1,6
	10	20	1,4	25.9	1,8
	10bis	23	1,6	38.7	2,7

**SPECIFICATIONS, CONT.**

**Table 11 Cont. - Spring Ranges**

Actuator	Spring	Spring Ranges			
		Minimum Set Pressure		Maximum Set Pressure	
	Name	psi	barg	psi	barg
<b>360</b>	1*	0.036	0,0025	0.21	0,014
	1bis	0.22	0,015	0.25	0,018
	2bis	0.27	0,019	0.56	0,039
	3	0.33	0,023	0.92	0,063
	4	0.42	0,029	1.1	0,073
	4bis	0.50	0,035	1.7	0,12
	6	1.0	0,071	2.7	0,19
	7	1.6	0,11	4.2	0,29
	8	2.4	0,17	4.4	0,31
	9	3.9	0,27	6.7	0,46
	9bis	4.9	0,34	7.3	0,50
10	6.2	0,43	8.0	0,55	
10bis	6.9	0,48	1.22	0,84	
<b>515</b>	1*	0.017	0,0012	0.11	0,0077
	1bis	0.09	0,0059	0.14	0,010
	2bis	0.12	0,0080	0.30	0,021
	3	0.15	0,0100	0.50	0,034
	4	0.20	0,014	0.6	0,04
	4bis	0.24	0,016	0.9	0,06
	6	0.5	0,036	1.5	0,10
	7	0.9	0,06	2.3	0,16
	8	1.3	0,09	2.4	0,17
9	2.1	0,14	3.3	0,23	

Spring ranges are based on the following assumptions:

- Stroke from setpoint is  $\pm 3$ mm
- Offset max 20% for minimum set pressure
- Low unbalancing forces on the plug

If different operating conditions are required, please contact Jordan Valve.

\* Thin diaphragm (FKM 0,18mm) and upside down installation.



**SPECIFICATIONS, CONT.**

**Table 12 - Weights | Actuators: 100, 120, 130, 140**

	NPT/GAS	Class 150 RF	PN 16/25/40	Class 300 RF	Class 600 RF
1/2" (DN15)	36.8 lbs (16,7 kg)	43.2 lbs (19,6 kg)	44.5 lbs (20,2 kg)	43.7 lbs (19,8 kg)	44.3 lbs (20,1 kg)
3/4" (DN20)	36.8 lbs (16,7 kg)	43.2 lbs (19,6 kg)	45.9 lbs (20,8 kg)	46.1 lbs (20,9 kg)	47 lbs (21,3 kg)
1" (DN25)	36.6 lbs (16,6 kg)	45.4 lbs (20,6 kg)	47.2 lbs (21,4 kg)	47.4 lbs (21,5 kg)	48.1 lbs (21,8 kg)
1-1/2" (DN40)	36.4 lbs (16,5 kg)	47.6 lbs (21,6 kg)	49.8 lbs (22,6 kg)	52.5 lbs (23,8 kg)	54.7 lbs (24,8 kg)
2" (DN50)	N.A.	50.9 lbs (23,1 kg)	53.1 lbs (24,1 kg)	54.2 lbs (24,6 kg)	57.5 lbs (26,1 kg)

**Table 13 - Weights | Actuator: 220**

	NPT/GAS	Class 150 RF	PN 16/25/40	Class 300 RF	Class 600 RF
1/2" (DN15)	46.7 lbs (21,2 kg)	53.1 lbs (24,1 kg)	44.5 lbs (20,2 kg)	54.5 lbs (24,7 kg)	54.2 lbs (24,6 kg)
3/4" (DN20)	46.7 lbs (21,2 kg)	53.1 lbs (24,1 kg)	45.9 lbs (20,8 kg)	56 lbs (24,5 kg)	56.9 lbs (25,8 kg)
1" (DN25)	46.5 lbs (21,1 kg)	55.3 lbs (25,1 kg)	47.2 lbs (21,4 kg)	57.3 lbs (26 kg)	58 lbs (26,3 kg)
1-1/2" (DN40)	46.3 lbs (21 kg)	57.5 lbs (26,1 kg)	49.8 lbs (22,6 kg)	62.4 lbs (28,3 kg)	64.6 lbs (29,3 kg)
2" (DN50)	N.A.	60.9 lbs (27,6 kg)	53.1 lbs (24,1 kg)	64.2 lbs (29,1 kg)	67.5 lbs (30,6 kg)

**Table 14- Weights | Actuator: 360**

	NPT/GAS	Class 150 RF	PN 16/25/40	Class 300 RF	Class 600 RF
1/2" (DN15)	79.6 lbs (36,1 kg)	86 lbs (39 kg)	87.3 lbs (39,6 kg)	86.4 lbs (39,2 kg)	87.1 lbs (39,5 kg)
3/4" (DN20)	79.6 lbs (36,1 kg)	86.6 lbs (39,3 kg)	88.6 lbs (40,2 kg)	88.8 lbs (40,3 kg)	89.7 lbs (40,7 kg)
1" (DN25)	79.4 lbs (36 kg)	88.2 lbs (40 kg)	90 lbs (40,8 kg)	90.2 lbs (40,9 kg)	58 lbs (41,2 kg)
1-1/2" (DN40)	46.3 lbs (21 kg)	57.5 lbs (26,1 kg)	49.8 lbs (22,6 kg)	62.4 lbs (28,3 kg)	64.6 lbs (29,3 kg)
2" (DN50)	N.A.	60.9 lbs (27,6 kg)	53.1 lbs (24,1 kg)	64.2 lbs (29,1 kg)	67.5 lbs (30,6 kg)

**Table 15 - Weights | Actuator: 515**

	NPT/GAS	Class 150 RF	PN 16/25/40	Class 300 RF	Class 600 RF
1/2" (DN15)	58.2 lbs (26,4 kg)	64.6 lbs (29,3 kg)	65.9 lbs (29,9 kg)	65 lbs (29,5 kg)	65.71 bs (29,8 kg)
3/4" (DN20)	58.2 lbs (26,4 kg)	64.6 lbs (29,3 kg)	67.2 lbs (30,5 kg)	67.5 lbs (30,6 kg)	68.3 lbs (31 kg)
1" (DN25)	58 lbs (26,3 kg)	66.8 lbs (30,3 kg)	68.6 lbs (31,1 kg)	68.8 lbs (31,2 kg)	69.4 lbs (31,5 kg)
1-1/2" (DN40)	57.8 lbs (26,2 kg)	69 lbs (31,3 kg)	71.2 lbs (32,3 kg)	73.9 lbs (33,5 kg)	76.1 lbs (34,5 kg)
2" (DN50)	N.A.	72.3 lbs (32,8 kg)	74.5 lbs (33,8 kg)	75.6 lbs (34,3 kg)	78.9 lbs (35,8 kg)

**DIMENSIONS**

**Mk608UBAN flanged valve dimensional drawings**

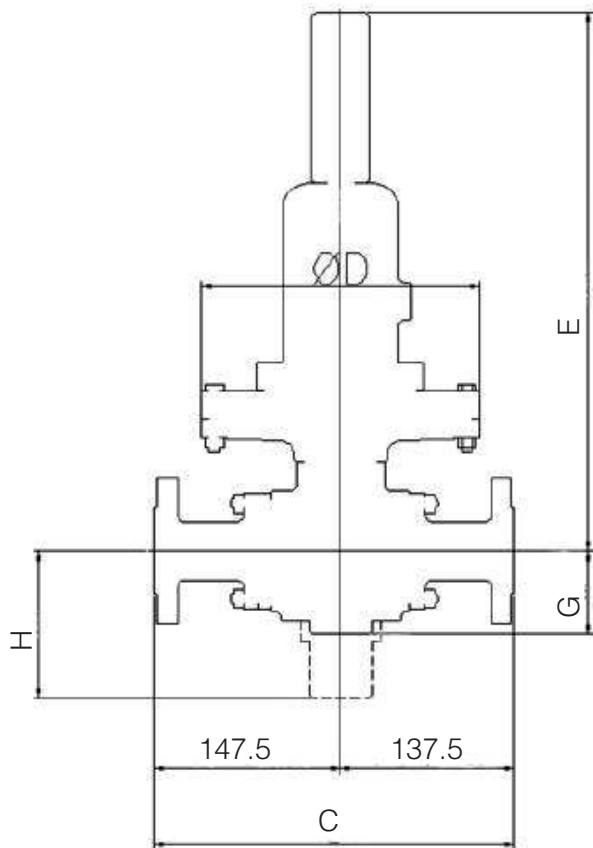

**Mk608UBAN threaded valve dimensional drawing**

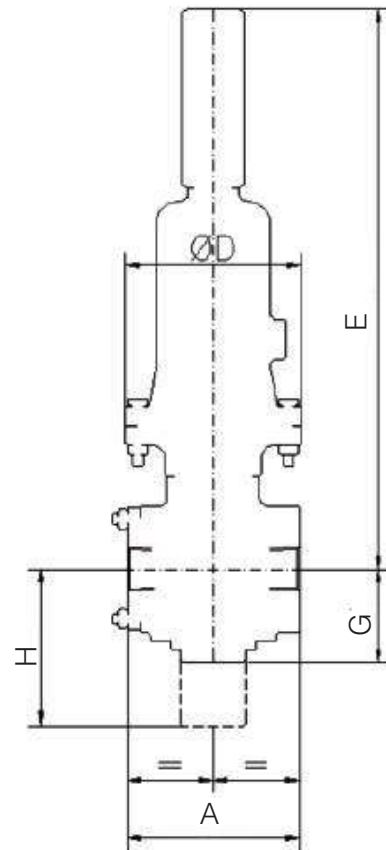
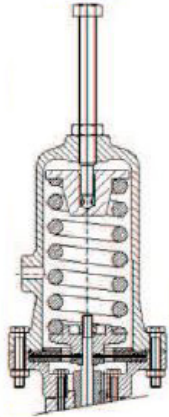

**Table 16 - Body Sizes and Face to Face Dimensions**

Size (DN)	Flanged			Threaded		
	PN 16			NPT-F		
	PN 25			NPT-F		
	PN40			GAS-F Con.		
	ANSI 150 RF			GAS-F Con.		
	ANSI 300RF			BSP-F		
	ANSI 600RF			BSP-F		
	A	B	C	A	B	C
1/2" (DN15)						
3/4" (DN20)						
1" (DN25)	11-1/4" (285mm)	3-1/8" (80mm)	4-1/2" (115mm)	5-1/8" (130mm)	3-1/8" (80mm)	4-1/2" (115mm)
1-1/2" (DN40)						
2" (DN50)				N.A.	N.A.	N.A.

**MK608UBAN ACTUATORS**

**Actuator 100/120**



**Actuator 130**

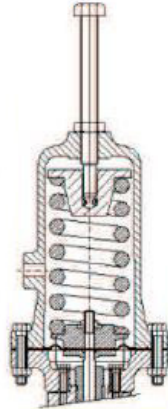

**Actuator 140**

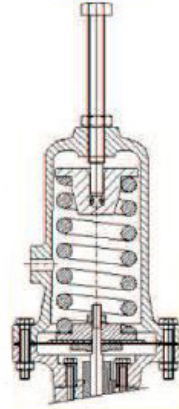

**Actuator 220**

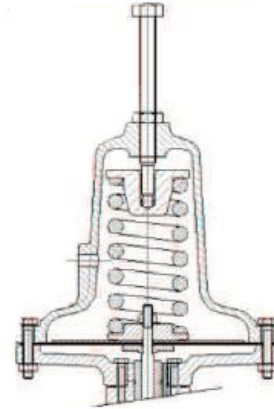

**Actuator 360**

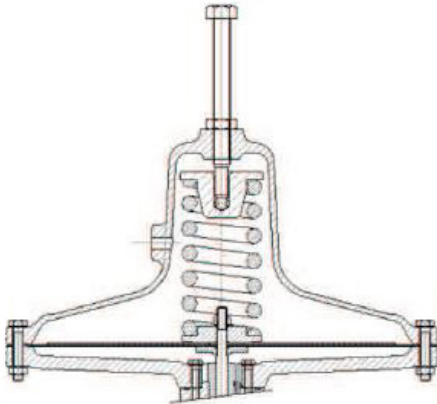

**Actuator 515**

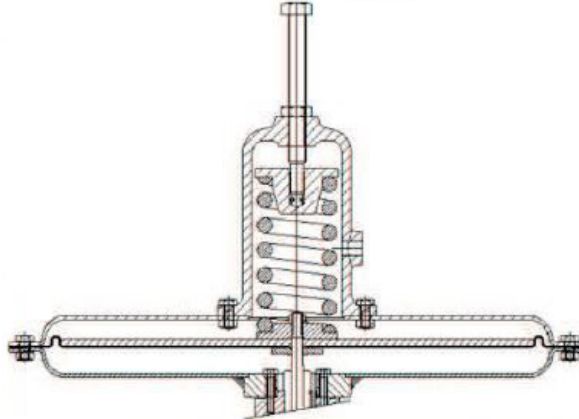

**MK608UBAN Actuators:**

The above drawings show all our available actuators, which are perfectly interchangeable the one with the others according to desired pressure regulation (please refer also to Table 4). The table below shows the actuators dimensions.

**Table 17 - Actuator Dimensions**

Actuator Dimensions		
Actuator	Surface	Outer Diameter
	in <sup>2</sup> (cm <sup>2</sup> )	mm
100	1.5 (9,7)	132
120	3.2 (20,7)	132
130	4.3 (27,8)	132
140	10 (64,5)	140
220	35.1 (226,5)	220
360	113.2 (730,1)	360
515	208.6 (1346)	480



**Jordan Valve a division of Richards Industries**  
 3170 Wason Road • Cincinnati, OH 45209  
 513.533.5600 • 800.543.7311 • 513.871.0105 (f)  
 info@richardsind.com • www.jordanvalve.com

*Jordan Valve reserves the right to make revisions to its product, specifications, literature and related information without notice. Please visit our website at [www.jordanvalve.com](http://www.jordanvalve.com) for the latest information on our products.*