

Instruction, Use and Maintenance Manual



SIGHT GLASS
BBTRD

Bardiani Valvole S.p.A.

via G. di Vittorio, 50/52 - 43045 Fornovo di Taro (PR) - Italy

tel. +39 0525 - Fax 0525 3408

bardiani@bardiani.com - www.bardiani.com

MANUAL REVISION	DATE

INDEX

1	Safety, Warning and Mandatory Signs	5
1.1	Operator training	8
2	Safety	9
2.1	General safety warnings	9
3	Technical data	10
4	Checking / Unpacking / Lifting	11
5	Installation	12
6	Troubleshooting	12
7	Disposal	13
8	Maintenance	14
8.1	General maintenance	14
8.2	Scheduled maintenance	14
9	Tools useful for Disassembly/Reassembly	15
10	Sight glass BBTRD	16
10.1	Disassembly of the BBTRD	18
10.2	Assembly of the BBTRD	19
11	Annexes	20
12	2D diagram BBTRD	21
13	Warranty	22
14	Recommendations	23

INTRODUCTION

This "Instruction, Use and Maintenance Manual" has been prepared to provide guidance and recommendations to assist qualified skilled technicians in the understanding, running and maintenance of the Products supplied.

It forms an integral part of the Products supplied and must be read prior to any installation, operation and/or maintenance of all types of valves provided.

This manual must be saved for future reference and be kept readily available at the unit.

With regards to the use of valves compliant with EU Directive 2014/34/UE (ATEX), consultation of a specific manual is mandatory.

The essential characteristics of all types of valves described herein being consistent, the Manufacturer reserves the right to alter and or complement and or update at any time and with no obligation to notify so in writing, the data and or information relevant to the use of the valves described in this "Instruction, Use and Maintenance Manual".





A constantly updated version of this "Instruction, Use and Maintenance Manual" is available at the Manufacturer's website www.bardianivalvole.it.





Under no circumstance shall the Manufacturer be held liable for consequences resulting from failure and or improper use of the instructions contained in this Manual and relating to the installation, operating, maintenance and storage of the products.







All rights reserved.

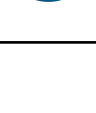



Full or part reproduction, transfer and or recording of any part of this "Instruction, Use and Maintenance Manual" by all means, whether it be electronic, on hard copy, mechanical or any other means or recording or reuse is strictly prohibited without the prior written consent of the Manufacturer and for any use other than that of the Buyer.







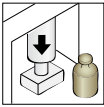
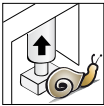

1 Safety, Warning and Mandatory Signs

WARNING SIGNS		
Pictogram	Description	Notes
	WARNING! General	This tells the person in question that the operation described involves (when not performed in accordance with the relative safety regulations) the risk of personal injury.
	WARNING! Hand crushing	Exercise caution in executing the procedure Hand crushing hazard
	WARNING! Heavy loads	Exercise caution in executing the procedure Heavy suspended loads.
	WARNING! Severe burns	Heat emission hazard Very hot surface, risk of severe burns
	WARNING! Risk of explosions	Take Care, risk of explosions

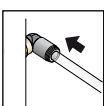
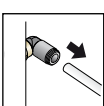
MANDATORY SIGNS (FOR THE OPERATOR IN CHARGE OF ASSEMBLY/DISASSEMBLY)		
Pictogram	Description	Notes
	OBLIGATION General	Special instructions must be followed to avoid injury to persons.
	PROTECTIVE GLOVES	Safety gloves must be available for handling objects which could cause hand injuries.
	HARD HAT	A hard hat must be worn during machine lifting operations to protect against hazards generated by suspended loads.
	FOOTWEAR	Use safety footwear to protect against the risks of falling objects during operations to transport the machine.
	SUITABLE CLOTHING	Suitable clothing such as overalls. It is strictly prohibited to wear clothes with large flapping sleeves and/or other loose items which could easily get caught up in machine parts.

MANDATORY SIGNS (FOR THE OPERATOR IN CHARGE OF MECHANICAL MAINTENANCE)		
Pictogram	Description	Notes
	OBLIGATION General	Special instructions must be followed to avoid injury to persons.
	PROTECTIVE GLOVES	Protective gloves must be available for handling objects which could cause hand injuries or when there is the possibility of coming into contact with harmful substances..
	HARD HAT	Hard hats must be available when lifting heavy parts.
	FOOTWEAR	Use safety footwear to protect against injuries caused by falling objects during maintenance operations (particularly when dismantling parts).
	SUITABLE CLOTHING	Suitable clothing such as overalls. It is strictly prohibited to wear clothes with large flapping sleeves and/or other loose items which could easily get caught up in machine parts.
	SAFETY GLASSES	Protective glasses must be available when there is the possibility of contact which harmful substances which could cause eye injuries.

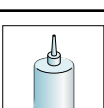
OPERATING SIGNS		
Pictogram	Description	Notes
	PERSONAL PERSONNEL	Dismantling/Assembling and maintenance operations must be carried out by expert technicians only.
	NOTE	Follow the indicated note with care
	ENVIRONMENTAL NOTE	Follow the regulations in force in the country of used governing waste disposal.
	CLAMP	Use of a clamp
	CLAMP WITH SOFT JAWS	Use of a clamp with jaws made from soft material

OPERATING SIGNS		
Pictogram	Description	Notes
	PRESS	Use of a press
	PRESS (release)	Use of a press Gradual release of the pressure force
	ELECTRICAL CONNECTION	Electrical connection to the control unit (consult the relative instruction manual).
	ELECTRICAL DISCONNECTION	Electrical disconnection from the control unit (consult the relative instruction manual).
	PNEUMATIC CONNECTION	Connection of the air to the valve.
	PNEUMATIC DISCONNECTION	Disconnection of the air from the valve
	APPLICATION OF FOODSAFE GREASE	Use FOODLUBE HI-TEMP 2 grease or similar.
	APPLICATION OF FOODSAFE GREASE	Use FOODLUBE Multi-paste grease or similar.
	APPLICATION OF MULTIPURPOSE GREASE	Use AGIP GREASE MU EP 2 SE or similar.
	THREADLOCK APPLICATION	Use SPEED BOND M500 threadlock or similar.
	OPTIONAL	

1.1 Operator training



All persons who have to work on the valve must be qualified to carry out the relative maintenance tasks. They must be informed as to the possible hazards involved and must observe all the safety instructions set out in this manual. Allow expert personnel only to work on the electrical components.

2 Safety

2.1 General safety warnings



Intended use

Bardiani sight glasses are designed exclusively for moving fluids.

Prohibited use

The sight glass must not be used:

- for any operations different to those described under the heading “Intended Use”,
- for handling fluids different to the type specified by the manufacturer and indicated in the sight glass technical data;
- for moving fluids at different pressures to those envisaged by the manufacturer and indicated in the sight glass technical data.

Limitations on sight glass use

It is forbidden to:

- use the sight glass in a construction configuration different to the one envisaged by the manufacturer.
- use the sight glass where there is a risk of explosion and/or fire, unless envisaged by the manufacturer (if the sight glasses are certified in accordance with Directive 2014/34/EU, please refer to the ATEX Manual);
- integrate other systems and/or equipment which were not considered by the manufacturer during the executive design phase,
- use the sight glass for purposes other than those specifically envisaged by the manufacturer.



WARNING!

The machine may not be used inside premises where there is a potentially explosive atmosphere or risk of fire unless otherwise stated by the manufacturer (in the case of valves certified in accordance with Directive 2014/34/EU please refer to the ATEX Manual).



BARDIANI VALVOLE S.p.A. declines all liability for installation, use or maintenance which fails to comply with the indications provided in this manual!

3 Technical data

VALVE STRUCTURE DATA	
Maximum product pressure	10 bar (145 psi) DN25--80
	7 bar (101 psi) DN100
Material in contact with the product	AISI 316L stainless steel (1.4404) and glass
Gasket material in contact with the product	EPDM, FKM, HNBR and other gaskets on request. Check compatibility with products and detergents
Surface finish in contact with the product (FDA certification)	EPDM, FKM, MVQ (silicon), NBR (other types of gaskets available on request .
Surface finish in contact with the product:	Ra 0.8 mm (other types of finish available on request).

Contact Bardiani Valvole S.p.A. in the event of any doubts.

Pressure Equipment Directive (PED) 2014/68/EU

DN25 sight glasses are not included in compliance with Article 4, paragraph 3:

The sight glasses designed for use with gas, liquid gas, gases dissolved under pressure, steam and those liquids with a vapour

pressure at maximum admissible temperature exceeding 0.5 bar at normal atmospheric pressure (1.013 mbar) within the following limits:

- For group 2 fluids when the DN is over 32.

GASKET MATERIALS COMPATIBILITY			
Product	EPDM	FKM	HNBR
Temperature (applications with air)	from -10 to 140°C	from -10 to 200°C	from -10 to 130°C
Caustic soda 2%	60°C	30°C	To be checked
Nitric Acid 2%	60°C	80°C	To be checked
Saturated steam 125°C	Suitable	To be checked	Suitable
Greases	Unsuitable	Suitable	Suitable
Alcohols	Suitable	Unsuitable	Suitable

Contact Bardiani Valvole S.p.A. in the event of any doubts.

4 Checking / Unpacking / Lifting

1. CHECK:

- Make sure the sight glass shows no signs of damage caused during transport and that it corresponds with the order;
- Check the inside of the sight glass.



2. UNPACKING

The sight glass packaging is made up of cardboard, wood and plastic. The sight glass is mainly made up of metal materials. The gaskets are usually made from elastomers. Disposal must be in compliance with local legislation.



3. VALVE LIFTING:

It is necessary to use suitable methods of rigging and transport (forklift, pallet jack, etc.) based on the weight of the sight glass.

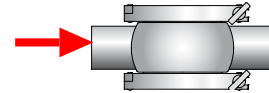

CAUTION!

The figures above are used purely to represent the methods and procedures for hoisting the valves. Bardiani Valvole S.p.A. declines all liability for any damage to things and/or injuries to persons caused by improper and/or incorrect hoisting of the valve.

VVF	
Size DN	Lifting method
15--125	A
150	B

A

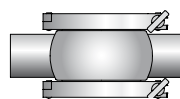

Weight up to 25 kg

B

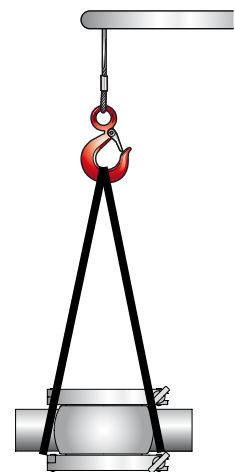

Weight between 25 kg and 50 kg



CAUTION!

The figures above are used purely to represent the methods and procedures for hoisting the valves. Bardiani Valvole S.p.A. declines all liability for any damage to things and/or injuries to persons caused by improper and/or incorrect hoisting of the valve.

5 Installation



1. ELECTRICAL AND PNEUMATIC ENERGY SUPPLY

- Use expert personnel for installation/uninstallation operations;
- The sight glass must be installed on the line where it will not cause any bending or twisting due to its weight. It is advisable to connect it to the line using piping of a material with at least equal characteristics to those of the sight glass.



CAUTION!

Always check the compatibility of the materials with the fluids being handled and observe the prescribed limits of use (pressure, temperature).

6 Troubleshooting



PROBLEM	POSSIBLE CAUSE	POSSIBLE SOLUTION
External leak	Worn gaskets	Replace the gaskets
	Pressure too high	
	Temperature too high	Replace the gaskets with a different type

EXAMPLE OF INTERNAL WASHING CYCLE (CIP)		
Phases	Temperature °C	Washing product
Initial rinse	Environment	Chlorine- and chloride-free water
Washing	70 °C	Caustic soda (NaOH) at 1%
Intermediate rinse	Environment	Chlorine- and chloride-free water
Washing	70 °C	Nitric acid (HNO ₃) at 0.5%
End rinse	Environment	Chlorine- and chloride-free water

Recommended washing product velocity = 2m/s

7 Disposal



At the end of its service life, the device must be recycled in accordance with the legislation in force in the country of valve use.

Any hazardous residues must be taken into consideration and adequately handled.

The valve is made of AISI 316L and AISI 304 stainless steel, elastomers (gaskets), plastic (control unit) and electrical components (terminal boards, solenoid valves, sensors).

Adhere to the following steps before disconnecting the valve and refer to the heading "General Maintenance".

- make sure the line on which the valve is installed in is not in use
- empty the line on which the valve is installed and clean if necessary
- disconnect the air supply if it is not required during dismantling
- disconnect the valve from the power supply
- remove the valve from the system
- move the valve in observance of the rules set out in the heading "Lifting"
- to dismantle the valve, refer to the heading "Disassembly"

8 Maintenance

8.1 General maintenance



1. MAINTENANCE PRECAUTIONS

Maintenance operations must be carried out by expert technicians only.



WARNING!

Before carrying out any maintenance operations, make sure the line to which the sight glass is connected is not running, that no liquid is flowing and that there is no internal pressure.

8.2 Scheduled maintenance

SCHEDULED MAINTENANCE	SIGHT GLASS GASKETS
Preventive	Replace after 12 months
In the event of leaks	Replace at the end of the day
Periodical	Check correct operation and that there are no leaks
	Record all the interventions carried out

9 Tools useful for Disassembly/Reassembly

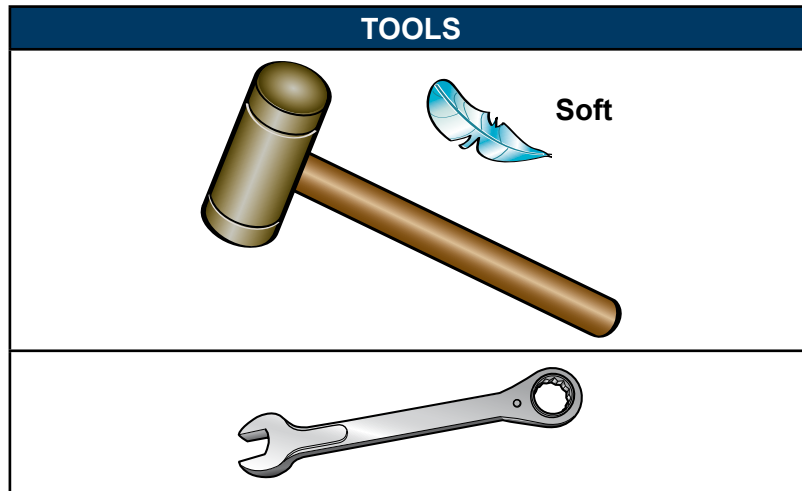

10 Sight glass BBTRD

NO.	DESCRIPTION
1	Body
33	Clamp
52	Cap
95	Sealing ring
157	Sealing ring
257	Sight glass

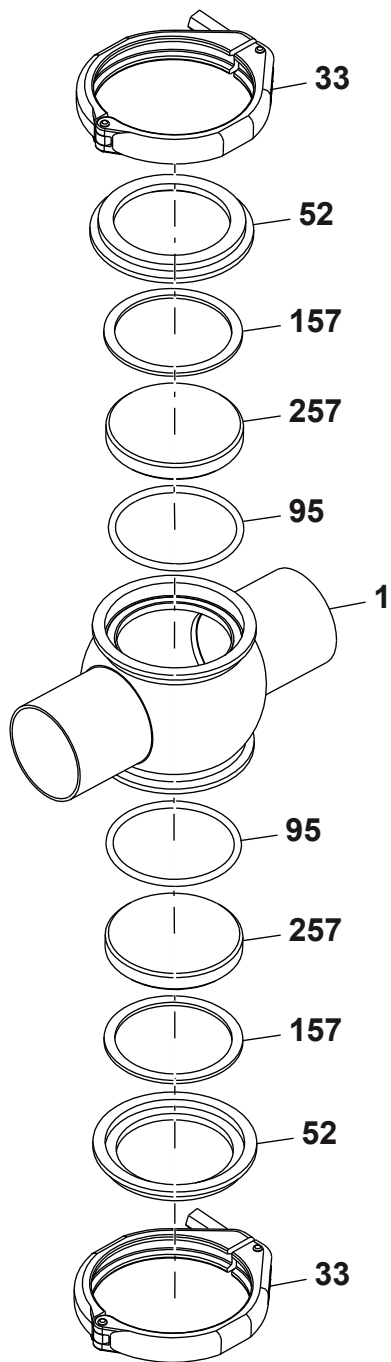

10.1 Disassembly of the BBTRD

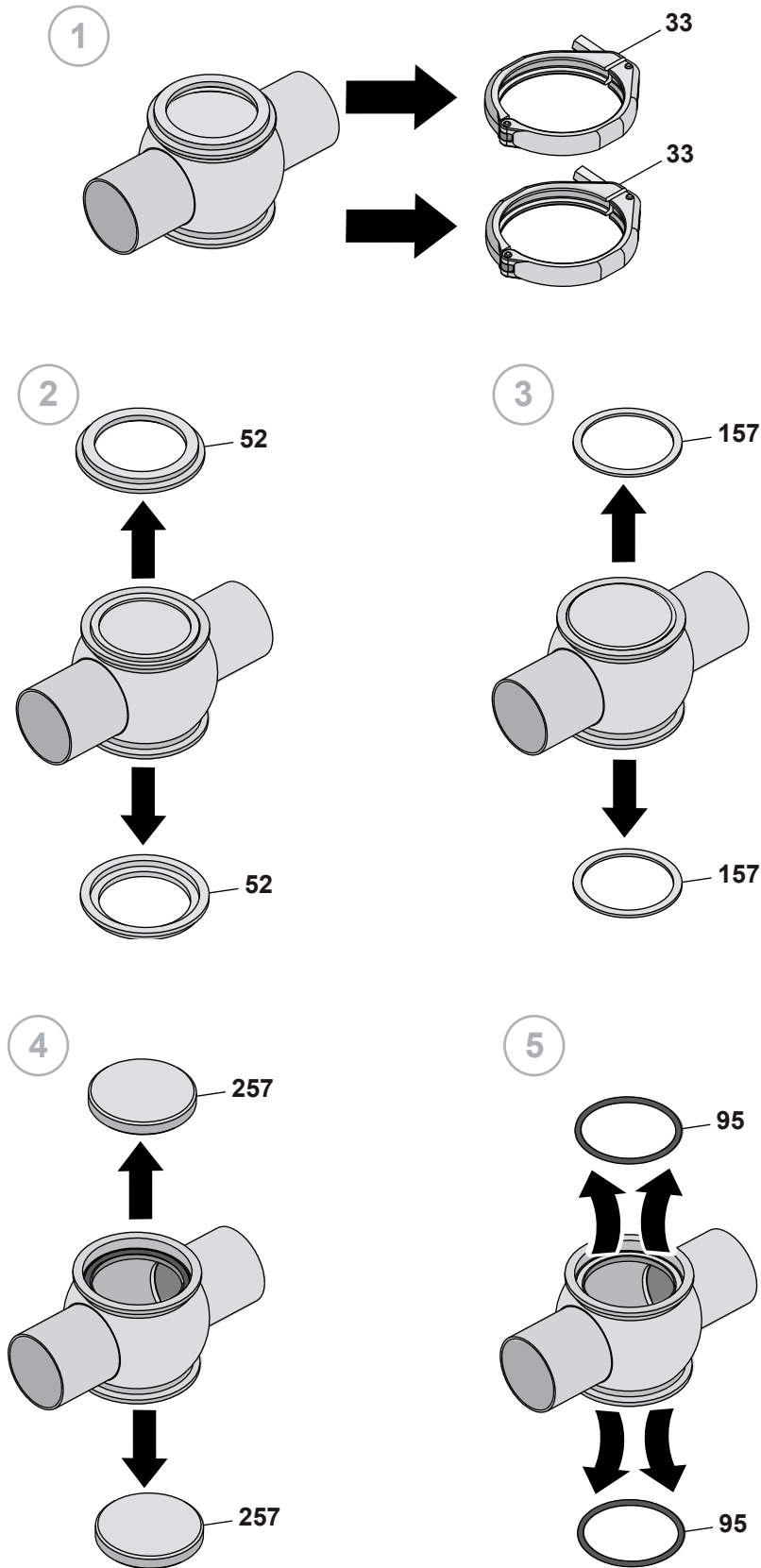

10.2 Assembly of the BBTRD

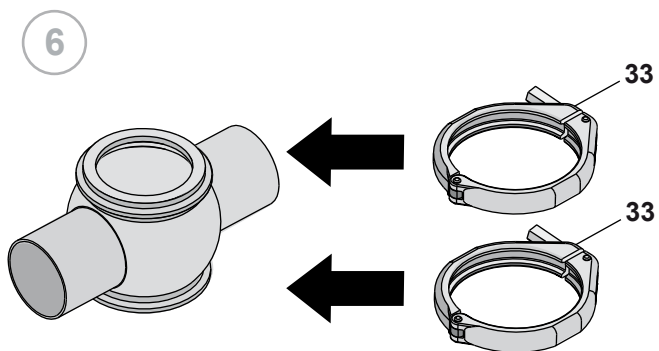
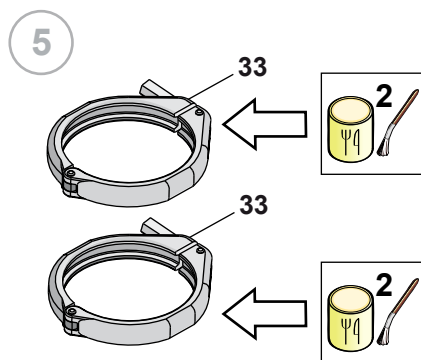
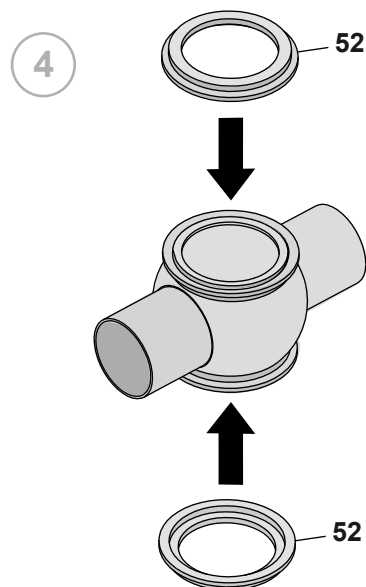
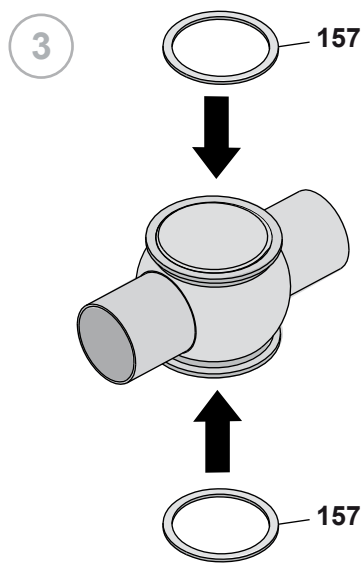
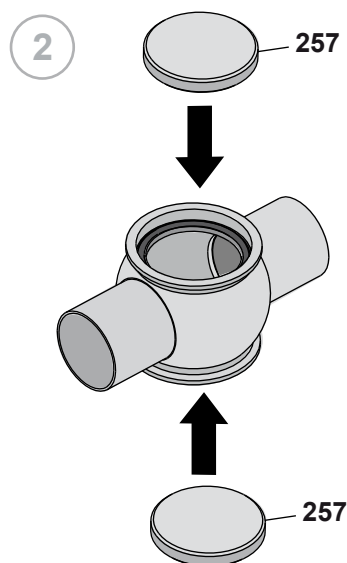
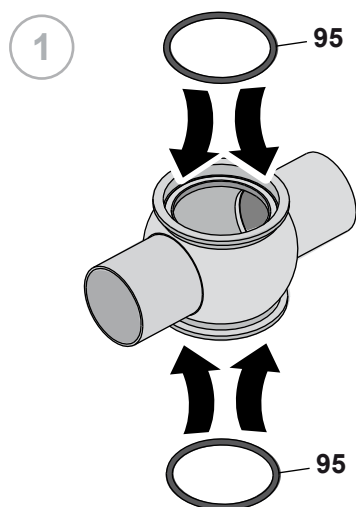

11 Annexes

ATTACKED DOCUMENTATION	
Code	Description

12 2D diagram BBTRD

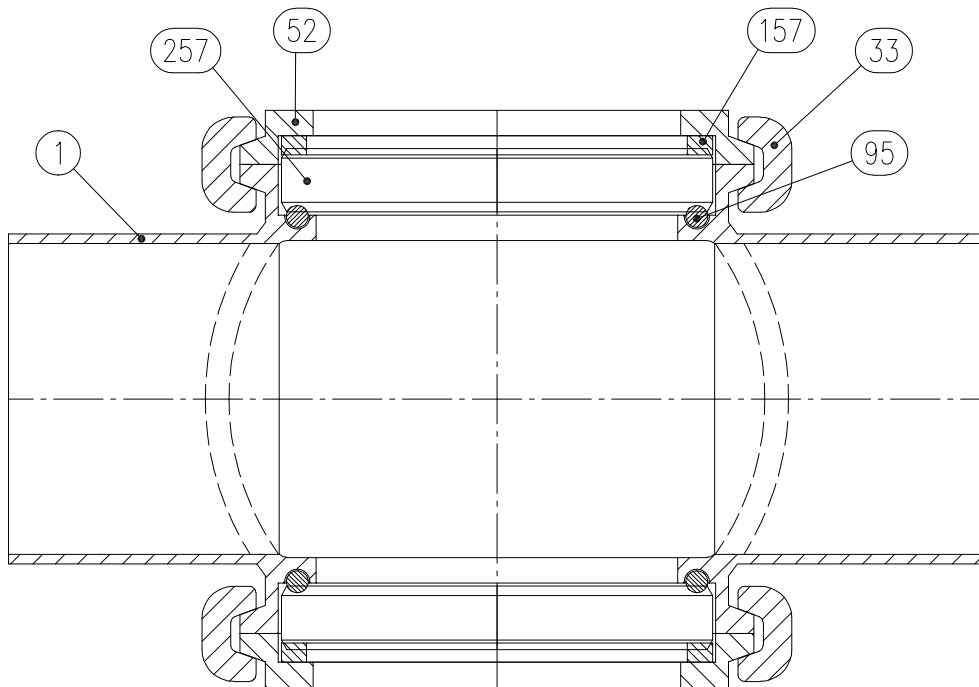

[BBTRD]

13 Warranty

1. VALIDITY

Bardiani Valvole's Products are manufactured in compliance with the technical specifications laid out in their "Instruction, Use and Maintenance Manual" and are fully compliant with the directives specifically mentioned in these manuals.

Bardiani Valvole S.p.A. guarantees its own Products against any design and/or construction and/or material defects and/or faults for a period of 12 (twelve) months from the date of delivery.

Notification of any Product defects and/or faults must be sent in writing to Bardiani Valvole S.p.A. within 8 (eight) days from their detection, providing adequate documentation of the defect/fault encountered as evidence.

Services provided in the warranty period shall not result in an extension of the warranty beyond the stipulated 12 (twelve)-month period, as this warranty validity period is to be considered mandatory.

2. CONTENTS OF THE WARRANTY

Notwithstanding and without prejudice to the rights of the Buyer, which may be acknowledged by applicable law, this warranty is to be intended as limited, at the discretion of Bardiani Valvole S.p.A., to the repair and/or replacement of the Product and/or part of the Product and/or its components which is/are found to be defective due to design and/or manufacturing and/or material faults.

- In the event of repair and/or replacement of the Product and/or any one of its parts and/or components, any returned item/s shall become the property of Bardiani Valvole S.p.A. and the relative shipping costs shall be charged to Bardiani Valvole S.p.A.
- Bardiani Valvole S.p.A., shall be under no obligation to compensate for any immaterial and/or indirect damages and shall in no way be held liable for consequential damages and/or losses, such as (by way of example only), damages due to loss of business, contracts, opportunities, time, production, profits, goodwill, image etc.
- No retailer or distributor or dealer or agent or representative or employee or person appointed by Bardiani Valvole S.p.A. is authorized to make any amendments and/or integrations and/or extensions to this warranty.

3. WARRANTY EXCLUSIONS

- Elastomers and electrical components are expressly excluded from this warranty.
- This warranty does not cover design faults emerging whenever a Product is manufactured by Bardiani Valvole S.p.A. based on designs and/or technical specifications provided by the Buyer.
- Moreover this warranty excludes the following:
- faults and/or defects resulting from incorrect and/or unsuitable and/or inadequate transportation of the Product;
- faults and/or defects resulting from failure to comply with the indications laid out in the "Instruction, Use and Maintenance Manual" with regards to installation of the Product or in any event caused by incorrect and/or unsuitable and/or improper installation;
- faults and/or defects resulting from failure to comply with indications laid out in the "Instruction, Use and Maintenance Manual" with regards to use and/or maintenance operations and/or storage of the Product or in any event caused by incorrect and/or unsuitable and/or improper use and/or maintenance operations and/or storage;
- faults and/or defects due to normal wear and tear of the Product and/or its parts and/or its components;
- faults and/or defects in the Product and/or its parts and/or its components for work and/or repairs being carried out by unskilled staff or staff that has not been authorised by Bardiani Valvole S.p.A.;
- faults and/or defects in the Product and/or its parts and/or its components caused by its being dropped and/or banged and/or dented and/or misused and/or tampering and/or breakage and/or accidents and/or any other event caused by negligence and/or carelessness and/or neglect by the Buyer and in general for any causes not ascribable to design and/or manufacturing and/or material defects;
- faults and/or defects in the Product and/or its parts and/or its components caused by other events beyond the control of Bardiani Valvole S.p.A., such as force majeure or unforeseeable circumstances.

14 Recommendations

- 1.** Consultation of the "Instruction, Use and Maintenance Manual" is mandatory prior to the installation, use and maintenance of the products of all Products. All the information, indications, specifications, technical details provided herein are based on test data which the Manufacturer Bardiani Valvole S.p.A. holds to be reliable nevertheless the above is not deemed to be assumed as fully exhaustive inasmuch as not every possible use has been envisaged.
- 2.** All the illustrations and drawings provided are to be intended as indicative and therefore not binding, the Products illustrations being for presentation purposes only.
- 3.** It is the Buyer's duty to assess the suitability of the products for the use he intends to make of the same prior to placing the order as he/she will take the risks and accept liability in case of incorrect choice and use of the Products.
- 4.** The Manufacturer strongly recommends the Buyer to contact their sales team and request any information that might be needed in relation to the specifications and uses of the Products.
- 5.** The information provided in this manual refers to the standard products manufactured by Bardiani Valvole S.p.A. and therefore cannot be assumed to apply to customized products as well.
- 6.** Bardiani Valvole S.p.A. reserves the right to amend and/or integrate and/or update the data and/or information and/or technical details relative to Products at any time and without prior notice. Please visit the website www.bardiani.com, where the latest updated of the "Instruction, Use and Maintenance Manual" can be found".
- 7.** The content and validity of the warranty covering the Products of Bardiani Valvole S.p.A are dealt with in the relevant section in the "Instruction, Use and Maintenance Manual" which constitutes an integral part of the Products themselves.
- 8.** Bardiani Valvole S.p.A., shall not in any way be held liable for immaterial, indirect and consequential damages, such as (by way of example only), damages or loss of business, contracts, opportunities, time, production, profits, goodwill, image etc..



NOTES

Empty area for notes.

NOTES

Bardiani Valvole S.p.A.
via G. di Vittorio, 50/52 - 43045 Fornovo di Taro (PR) - Italy
tel. +39 0525 400044 - fax +39 0525 3408
bardiani@bardiani.com - www.bardiani.com