

# BioProTT™ FlowTrack SL User Manual

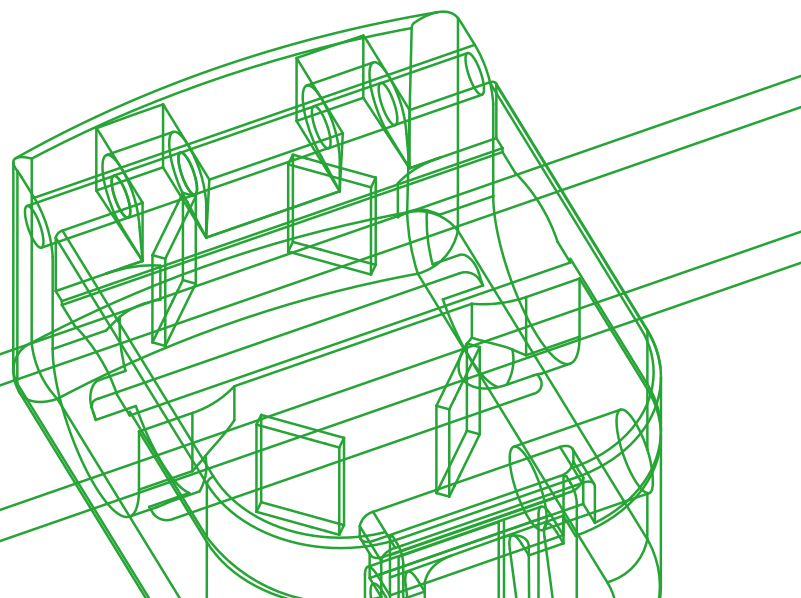
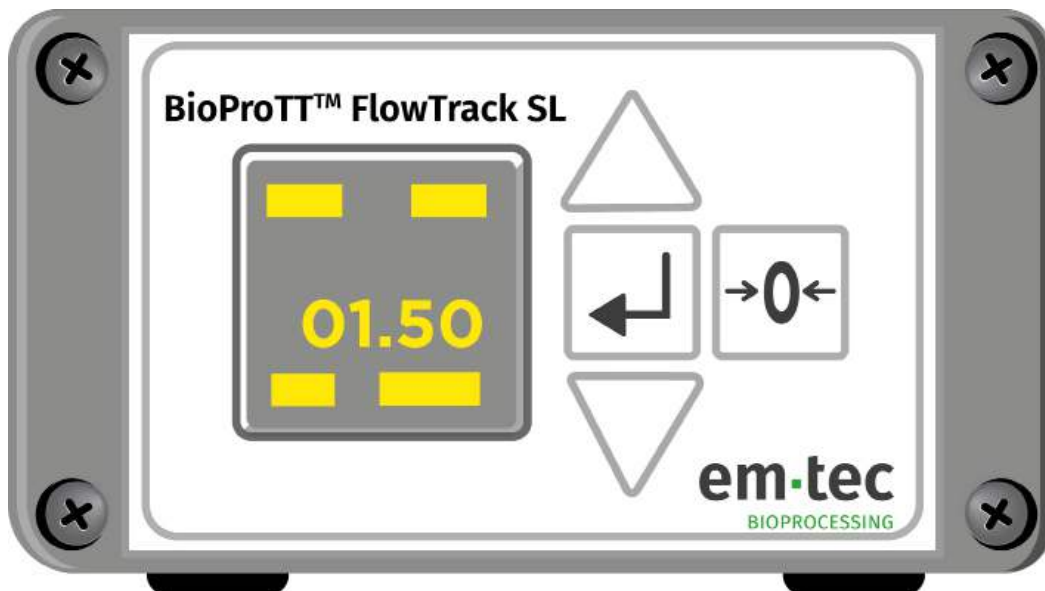

## **Copyright**

All rights reserved, especially with respect to reproduction, distribution and translation. This user manual or any part thereof must not be reproduced, saved, processed, duplicated or distributed without the written consent of em-tec GmbH.

© Copyright 2022 em-tec GmbH Finning. –All rights reserved.

## **Subject to Technical Changes**

Owing to our policy of continuous product development, the illustrations and technical data contained in this document may differ slightly from the current version of the device.

## **Legal Manufacturer**

em-tec GmbH  
Lerchenberg 20  
86923 Finning  
GERMANY

Telefon: +49 8806 9236 0  
Fax: +49 8806 9236 50  
E-Mail: [em-tec-info@psgdover.com](mailto:em-tec-info@psgdover.com)  
Internet: [www.em-tec.de](http://www.em-tec.de)





## Table of Contents

<b>1</b>	<b>Intended Purpose and Restrictions.....</b>	<b>7</b>
1.1	Intended Purpose .....	7
1.2	Usage Restrictions and Limitations.....	7
1.3	Liabilities and Responsibilities .....	7
1.4	Safety Instructions .....	8
1.5	Notice Concerning Compulsory Registration .....	8
1.6	Electrical Safety and Electromagnetic Compatibility .....	9
1.7	Ultrasonic Safety regarding Acoustic Output.....	9
1.8	Maintenance and Service.....	10
<b>2</b>	<b>General Safety Information, Symbols, Units and Abbreviations.....</b>	<b>11</b>
2.1	Symbols used in these Operating Instructions .....	11
2.2	Symbols on External Power Supply Unit.....	11
2.3	Symbols on Flow Meter, Sensors and on Packaging.....	12
2.4	Definitions and Abbreviations .....	13
<b>3</b>	<b>Description of the Measurement Principle.....</b>	<b>14</b>
<b>4</b>	<b>Packaging Contents .....</b>	<b>15</b>
<b>5</b>	<b>BioProTT™ FlowTrack SL Device Description .....</b>	<b>16</b>
5.1	Rear Panel of the BioProTT™ FlowTrack SL.....	16
5.2	Front Panel of the BioProTT™ FlowTrack SL.....	17
5.3	Menu Structure of the BioProTT™ FlowTrack SL.....	18
<b>6</b>	<b>Installation and Powering of the BioProTT™ FlowTrack SL .....</b>	<b>19</b>
<b>7</b>	<b>BioProTT™ Clamp-On SL .....</b>	<b>21</b>
7.1	Installation of the BioProTT™ Clamp-On SL.....	21
7.2	Attaching the BioProTT™ Clamp-On SL to the Tube .....	21
7.3	Use of the BioProTT™ Clamp-On SL.....	22
7.4	Disassembly and Storage of the BioProTT™ Clamp-On SL .....	24
7.5	Exchanging the BioProTT™ Clamp-On SL .....	24
<b>8</b>	<b>Adjustment and Calibration of the BioProTT™ Clamp-On SL .....</b>	<b>24</b>
<b>9</b>	<b>General Settings and Functions of the BioProTT™ FlowTrack SL .....</b>	<b>25</b>
9.1	Screen Saver .....	25
9.2	Adjustment of Brightness .....	25
9.3	Flow Value and Coupling.....	26
9.4	Selection of a Calibration Table .....	26
9.5	Totalizing.....	27
9.6	Setting a Calibration Factor .....	29
<b>10</b>	<b>Flow Measurement with the BioProTT™ FlowTrack SL.....</b>	<b>30</b>
10.1	Flow Measurement Using the Digital Interface.....	30
10.2	Flow Measurement Using the Analog Interface .....	35
<b>11</b>	<b>Status Information.....</b>	<b>38</b>

<b>12</b>	<b>Cleaning and Disinfection .....</b>	<b>39</b>
12.1	Cleaning and Disinfection of the BioProTT™ FlowTrack SL.....	39
12.2	Cleaning and Disinfection of the BioProTT™ Clamp-On SL .....	39
<b>13</b>	<b>Loops for the BioProTT™ FlowTrack SL.....</b>	<b>40</b>
13.1	Current Loop Definitions for the BioProTT™ FlowTrack SL.....	40
13.2	Checking the Current Loops of the BioProTT™ FlowTrack SL.....	41
<b>14</b>	<b>Error Codes and Information.....</b>	<b>44</b>
<b>15</b>	<b>Troubleshooting .....</b>	<b>45</b>
<b>16</b>	<b>Environmental Protection and Disposal.....</b>	<b>51</b>
<b>17</b>	<b>Technical Specifications of the BioProTT™ FlowTrack SL .....</b>	<b>52</b>



- Read this user manual carefully before installing and starting up the device!
- This document describes the use of the BioProTT™ FlowTrack SL.
- The user (= the person who integrates the BioProTT™ FlowTrack SL into the application/process) is responsible for any risks if the BioProTT™ FlowTrack SL is not used and/or integrated correctly.
- The customer must ensure that the persons involved in the integration of the BioProTT™ FlowTrack SL are adequately qualified in regard to the integration of industrial and process measurement transmitters.
  - In addition, the information in this user manual must be followed.
- If the used BioProTT™ Clamp-On SL is exchanged for another BioProTT™ Clamp-On SL, or if the BioProTT™ Clamp-On SL is unplugged and reconnected, it must be reconfigured prior to the measurement.
- The BioProTT™ FlowTrack SL, the BioProTT™ Clamp-On SL(s), and the sensor lines are part of a sensitive sensor system. Electromagnetic fields or mechanic vibrations can lead to interferences affecting the measurements or the accurate function of the system.
- The BioProTT™ FlowTrack SL consists of components sensitive to electrostatic discharge.

Although the BioProTT™ FlowMeasurement System represents a state-of-the-art technology, the user may be put at risk if the device is operated incorrectly. You should therefore read this user manual carefully before use. In addition, inspect your equipment for completeness and damage when unpacking.

The user manual contains important information on the safe handling of the BioProTT™ FlowMeasurement System and its accessories. Read these instructions carefully before using the device and its accessories and keep them in an easily accessible location. Familiarize yourself with and observe all warning and safety information.

It is the responsibility of the operator of the device to ensure it is used, inspected, and maintained in accordance with the user manual. Subsequent revisions or instructions from the manufacturer must also be taken into account in this regard.

The manufacturer reserves the right to modify technical data without prior notice. Your local distributor will supply you with current information and updates to this document.

**Please note:**

- The term BioProTT™ FlowMeasurement System includes the flow meter, i.e. the BioProTT™ FlowTrack SL, and a BioProTT™ Clamp-On SL.
- The term BioProTT™ FlowTrack SL usually refers to the complete BioProTT™ FlowMeasurement System consisting of the flow meter and an em-tec BioProTT™ Clamp-On SL as well.
- This user manual covers the features of software version V3.1.0.0 and subsequent ones.
  - The exact software version on your device is displayed on the status information screen and/or can be accessed via the digital interface (see [chapter 10.1.3](#) for more information).

## 1 Intended Purpose and Restrictions

### 1.1 Intended Purpose

The BioProTT™ FlowMeasurement System is designed for the non-invasive measurement of volumetric flow rates of liquids. It is usually used in laboratory and industrial processes within the field of bioprocessing. The device must be used with a compatible em-tec sensor. The measurement is based on the ultrasonic transit time method.

### 1.2 Usage Restrictions and Limitations

The BioProTT™ FlowTrack SL was developed and is sold for the above-mentioned intended purpose and use only. The BioProTT™ FlowTrack SL and the BioProTT™ Clamp-On SLs are not intended to be used for the following purposes/under the following circumstances:

- as medical device
- for measuring gaseous media or explosive and/or flammable liquids
- for measurements in explosive areas
- for home or consumer use
- for outdoor use
- for legal metrology
- when the housing is damaged
- to control and regulate a safety operation of a plant or equipment, especially those requiring mandatory surveillance by law

Due to its single-channel structure, the BioProTT™ FlowTrack SL is not a fail-safe system. If applied in safety critical systems, the user has to consider a partial or complete system failure and is responsible for the introduction of additional risk measures in their system.

### 1.3 Liabilities and Responsibilities

It is the responsibility of the user to use, check and maintain the BioProTT™ FlowTrack SL and the BioProTT™ Clamp-On SL in accordance with this user manual. em-tec GmbH is neither liable nor responsible for any consequences arising from the use of the BioProTT™ FlowTrack SL and BioProTT™ Clamp-On SL that do not comply with the operating and safety instructions or the specifications in this document.

## 1.4 Safety Instructions

---



- The following safety instructions must be strictly observed and adhered to in order to ensure a safe handling of the device!
  - If the device or its accessories (cables, sensor, etc.) are damaged in any way, they must not be used. This is especially important if the cable insulation is damaged, or if any parts have broken off or are bent.
  - The power supply unit must not be immersed in liquids at any time and is only to be used in dry locations.
    - In the event of ingress of liquid into the device, immediately disconnect the power and stop using the device.
  - The use of any accessories, power supply units, cables, and sensors other than the specified ones is not permitted at any time.
  - If longer cables are used, or if more than one sensor line extension cable is used, the electromagnetic emission of the BioProTT™ FlowMeasurement System could increase or its immunity to interference could be reduced.
  - The BioProTT™ FlowMeasurement System may be influenced by radio frequency (RF) devices. This includes mobile RF communication equipment. The use of a RF device in the vicinity of the BioProTT™ FlowMeasurement System may therefore cause malfunctions of the components which, in turn, could lead to inaccurate or incorrect flow values.
  - The device should not be covered or exposed to direct heat or sun.
  - The device must not be opened. Any repairs must be carried out by em-tec GmbH or authorized service personnel only.
    - Unauthorized opening or repair means the warranty will be void.
  - The BioProTT™ FlowTrack SL should not come into contact with any chemicals other than those specified in chapter 12 "[Cleaning and Disinfection](#)".
- 

## 1.5 Notice Concerning Compulsory Registration

Any major incidents in any ways connected to the product must be immediately reported to the manufacturer.



## 1.6 Electrical Safety and Electromagnetic Compatibility

The BioProTT™ FlowMeasurement System was tested according to **IEC 61326-1: 2013** (Emission: Class A, Group 1) and **IEC 61010-1: 2010**.

Although the requirements of **IEC 61326-1: 2013** and **IEC 61010-1: 2010** were taken into account during the development and manufacturing, the user may be at risk if the system and/or any part thereof is used improperly.

### Electrical Installation Requirements

Please follow the general safety information when installing the BioProTT™ FlowMeasurement System. Please also observe any separate relevant safety and technical information of other electrical components used.

### Electromagnetic Compatibility Requirements

The customer has to ensure that the relevant emission and immunity requirements of the device configuration are ensured in accordance with the required standards.

Interference of ultrasonic flow measurements by electromagnetic fields could be possibly identified by compromised measurement data, which are not related to the real flow.

#### Please note:

The BioProTT™ Clamp-On SL is not galvanically isolated.



It is important to ensure that the BioProTT™ FlowMeasurement System is not placed near any disturbance source that is not compliant with the applicable standards since this could

- influence and negatively affect the measurement.
- impact the data stored on the sensor plug and permanently corrupt it.

Crossed lines and the use of extension cables might impact the data transfer and EMC compatibility.

---

## 1.7 Ultrasonic Safety regarding Acoustic Output

When in use, the connected BioProTT™ Clamp-On SLs produce very low-power ultrasonic signals at frequencies between 2.25 and 4 MHz. The emitted acoustic signals are within the range specified in **IEC 61157 2<sup>nd</sup> ed.** and **IEC 60601-2-37 2<sup>nd</sup> ed.**

If used as specified in this user manual, the acoustic signals produced by the BioProTT™ FlowTrack SL and BioProTT™ Clamp-On SL are, according to current knowledge, harmless for people and the environment.

## 1.8 Maintenance and Service

In general, em-tec GmbH recommends the device to be checked in regard to measuring accuracy and safety relevant aspects every two years.

The service for the BioProTT™ FlowTrack SL and the BioProTT™ Clamp-On SL may be carried out by em-tec GmbH only. If these instructions are not followed, em-tec GmbH shall accept no liability for the device and the warranty will be void.

If you experience any trouble with the measurement despite following the operating instructions, or if your BioProTT™ FlowTrack SL is damaged in any way, please contact our service department. Make a note of the serial number of the BioProTT™ FlowTrack SL and the sensor before you contact our staff.

If you need to return the BioProTT™ FlowTrack SL or the BioProTT™ Clamp-On SL for servicing, please follow these steps:

- Contact our service department at:  
em-tec GmbH  
Service Department  
Am Graben 6-8  
86923 Finning  
Germany  
[em-tec-service@psgdover.com](mailto:em-tec-service@psgdover.com)
- Our service department will send you a RMA form.
- Fill out the form and include it in the shipment.

## 2 General Safety Information, Symbols, Units and Abbreviations

### 2.1 Symbols used in these Operating Instructions













Symbol	Meaning
	Warning! This safety symbol precedes critical information that must be strictly observed in order to prevent injuries and fatal hazards. This warning symbol is the most important safety symbol.
	Caution! Important information regarding correct handling. Must be performed and strictly observed! If this information is not observed, faults or damage to the product or its surroundings may occur.

Table 1: Symbols Used in these Operating Instructions

### 2.2 Symbols on External Power Supply Unit

Symbol	Meaning
	Read this user manual carefully before use. Keep it in an easily accessible location for future reference. Replacement copies of this user manual are available from the manufacturer.
	Alternating current: Alternating current must be fed to the supplied external power supply unit. The values for the supply voltage must correspond to those of the power supply unit: 100-240 VAC/50-60 Hz.
	Friwo Gerätebau GmbH (manufacturer logo)
	SIQ Testing and Certification GmbH logo
	Protection Class II (protective insulation) As a safety guarantee, this power supply unit has additional insulation to prevent dangerous touch voltage in the event of a fault.
	Do not dispose of this device together with domestic waste! The device as a whole as well as any parts must be disposed of in accordance with WEEE Directive and national legislation.
	CE marking: The external power supply unit satisfies the requirements of Low Voltage Directive 2006/92/EC and EMC Directive 2004/108/EC
	VI Efficiency Mark
	UK Conformity Assessed
	European Norms Electrical Certification (22=ID of VDE)
	Direct current 24V DC from external power supply unit















Symbol	Meaning
	For indoor use only
	UL Listing Mark
	Mark by national testing body

Table 2: Symbols on External Power Supply Unit

## 2.3 Symbols on Flow Meter, Sensors and on Packaging

Symbol	Meaning
	Caution! Consult accompanying documents for important safety-related information such as warnings and precautions.
	Do not dispose of this device as domestic waste! Waste devices must be disposed of in accordance with WEEE Directive 2012/19/EU and national legislation.
	Manufacturer em-tec GmbH · Lerchenberg 20 · 86923 Finning · Germany
	Serial number
	Order number
	The manufacturer declares the conformity of the device with the applicable European Regulations and Directives.
	FCC mark: The device satisfies the requirements of the United States Federal Communication Commission.
	Caution, fragile! Handle with care!
	Protect against moisture! Store in a dry place.
	Temperature limit during storage
	Moisture limit during storage (non-condensing)
	Air pressure limit



Symbol	Meaning
	UK Conformity Assessed
	Storage
	Transport
<b>IP65</b>	Protected against dust and high pressure water jets from all directions

Table 3: Symbols on Flow Meter, Sensors and on Packaging

## 2.4 Definitions and Abbreviations

Definitions, Abbreviation	Meaning
PCT	BioProTT™ Clamp-On SL
sensor	BioProTT™ Clamp-On SL
EMC	<b>E</b> lectro <b>M</b> agnetic <b>C</b> ompatibility
flow meter	BioProTT™ FlowTrack SL
N/A	<b>N</b> ot <b>A</b> pplicable
PLC	<b>P</b> rogrammable <b>L</b> ogic <b>C</b> ontroller
ID	<b>I</b> nnner <b>D</b> iameter
OD	<b>O</b> uter <b>D</b> iameter
WT	<b>W</b> all <b>T</b> hickness
Qmax	Maximum flow
RSS	<b>R</b> eceived <b>S</b> ignal <b>S</b> trength which corresponds to the acoustic coupling

Table 4: Definitions and Abbreviations

### 3 Description of the Measurement Principle

The function of the BioProTT™ FlowTrack SL and the BioProTT™ Clamp-On SL is based on an acoustic measurement principle and utilizes the transit time method to determine the flow. A typical transit time flow measurement system incorporates two piezo ceramics that act as both ultrasonic transmitter and receiver. The measurement system, consisting of the BioProTT™ FlowTrack SL together with a BioProTT™ Clamp-On SL, operates by alternately transmitting and receiving an ultrasonic pulse between the ceramics and measuring the transit time difference that it takes for the pulse to travel between them.

This method determines the transit time difference of ultrasonic signals through a measuring section which is then used to estimate the volumetric flow rate. There are at least two sound transducers required in order to send and receive ultrasonic pulses both with and against the flow direction. For a higher accuracy, our BioProTT™ Clamp-On SLs incorporate two pairs of sound transducers, i.e. four piezo ceramics in total, which are arranged in an X-configuration around the tube containing the measured flow.

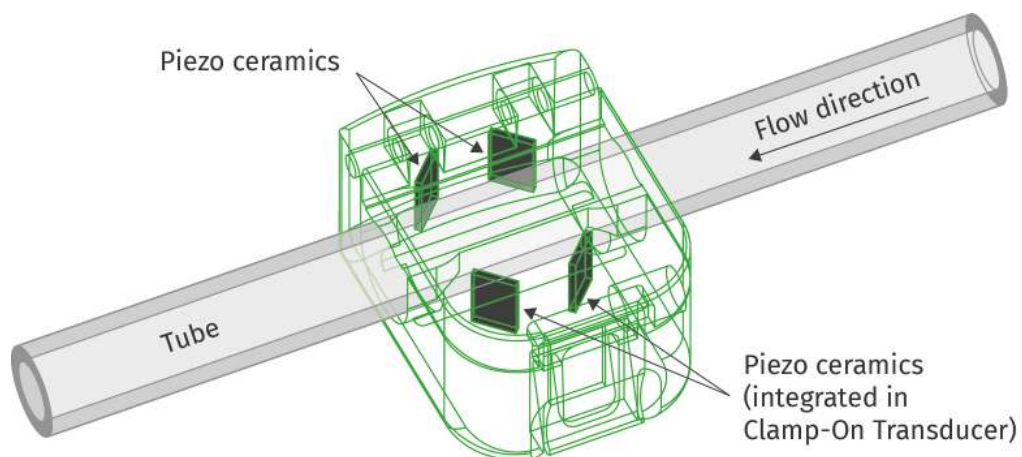

Figure 1: Sensor Structure

When sending ultrasonic signals through the measuring section, the transit time difference depends on the flow direction of the medium:

- The ultrasonic sound signals that are sent along the flow direction and volume flow of the medium, i.e. downstream, need less time to travel through the measurement section than
- the ultrasonic sound signals that are sent against the flow direction, i.e. upstream.

Consequently, the transit time difference is measured for every pulse. The difference between upstream and downstream measurements is proportional to the volumetric flow rate of the liquid in the tube. Therefore, by accurately measuring the difference between upstream and downstream transit time  $T_{up}$  and  $T_{down}$ , we are able to estimate the flow velocity. Subsequently, the volumetric flow rate is computed from the inner cross section area of the tube and the instrument coefficient. The calculation is carried out by the evaluation device.

## 4 Packaging Contents

The BioProTT™ FlowTrack SL is shipped together with

- one power supply unit
- adapters for the power supply
  - EURO
  - UK
  - US/Japan
  - Australia
  - IEC

Additionally available is an Accessory Kit (ID 13691) containing:

- 1x USB-RS232 Interface Cable
- 2x Connecting Cable for "Current Output"
- 1 x Connecting Cable for "Digital Output"

**Please note:**

The Accessory Kit must be ordered separately and is not part of the BioProTT™ FlowTrack SL's scope of supply.

## 5 BioProTT™ FlowTrack SL Device Description



- Compliance with the prescribed operating parameters and safety information must be ensured prior to the use of the device.
- The user is responsible for the integration of the device into their system, including the observation of safety aspects and electromagnetic compatibility.
- The following operating instructions must be strictly observed.

### 5.1 Rear Panel of the BioProTT™ FlowTrack SL

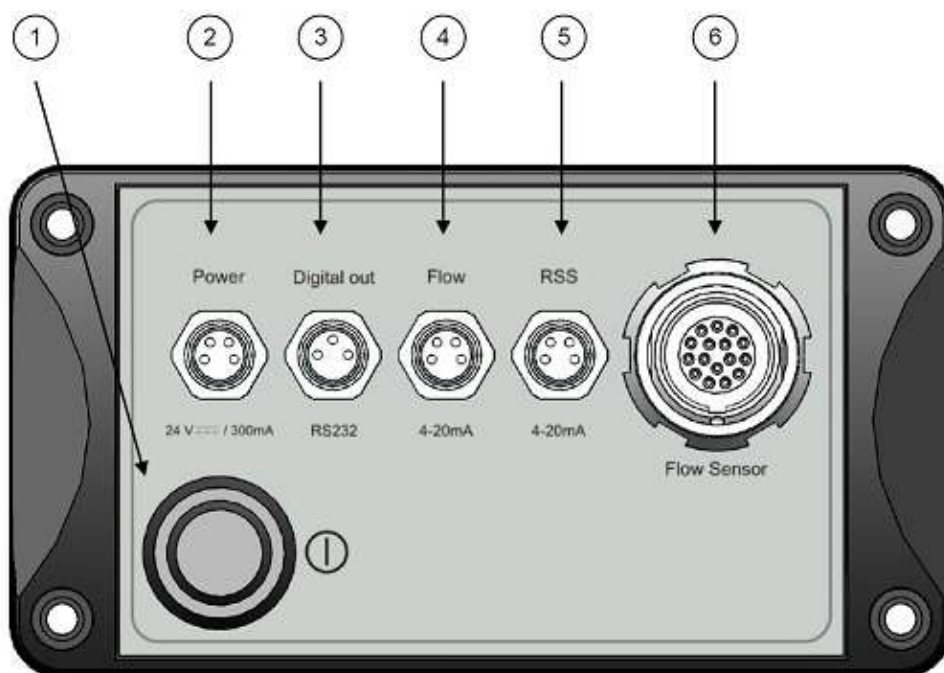

Figure 2: Rear Panel of the BioProTT™ FlowTrack SL

	Components	Description
1	On/Off Button	Push the button to switch the device on/off. <b>Note:</b> This button is only relevant if the power is supplied via the power socket. The button does not affect power supplied via the Flow or the RSS socket.
2	Power	4-pin connecting socket for DC power. <b>Note:</b> Only 2 pins are actually used.
3	Digital out	3-pin connecting socket for the digital interface.
4	Analog Flow	4-pin connecting socket for the analog flow signal.
5	Analog RSS	4-pin connecting socket for the analog RSS (RSS=Received Signal Strength)
6	BioProTT™ Clamp-On SL	16-pin connecting socket for the BioProTT™ Clamp-On SL connector with push and pull unlock mechanism.

Table 5: Rear Panel Components



## 5.2 Front Panel of the BioProTT™ FlowTrack SL

After pushing the on/off button at the rear panel, the device needs a few seconds for the initialization. The appearance of the "flow" screen indicates that the BioProTT™ FlowTrack SL is ready to be used.

**Please note:** The display is updated every second.

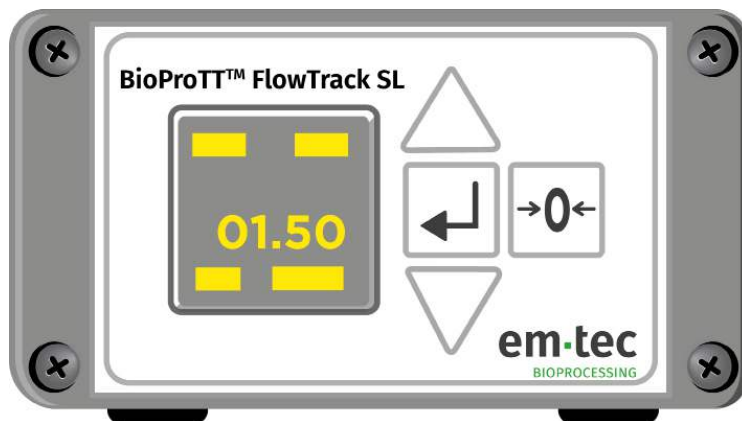

Figure 3: Front Panel of the BioProTT™ FlowTrack SL

### Basic operation of the device:



Button	Meaning
	<p>The up and down arrow buttons are used to</p> <ul style="list-style-type: none"> <li>• select a possible setting on the current screen</li> <li>• switch to the previous/next screen.</li> <li>• disable the screensaver function</li> </ul> <p><b>Please note:</b> If the selection of a value is possible, the word "sel" is displayed on the screen after the enter button was pressed.</p>
	<p>The enter button is used to</p> <ul style="list-style-type: none"> <li>• change to "sel" mode,</li> <li>• confirm a value or change and exit "sel" mode,</li> <li>• change from "hold" to "run" status when in totalizer mode.</li> </ul> <p><b>Please note:</b> Only press this button for a short time, otherwise the "sel" mode might remain activated.</p>
	<p>The zero adjustment button is used</p> <ul style="list-style-type: none"> <li>• for the zero adjustment of the flow</li> <li>• to reset the totalizer value(s) and exclamation mark.</li> </ul>

Table 6: Front Panel Components

## 5.3 Menu Structure of the BioProTT™ FlowTrack SL

Flow chart of the menu structure\*:

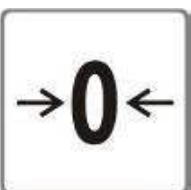
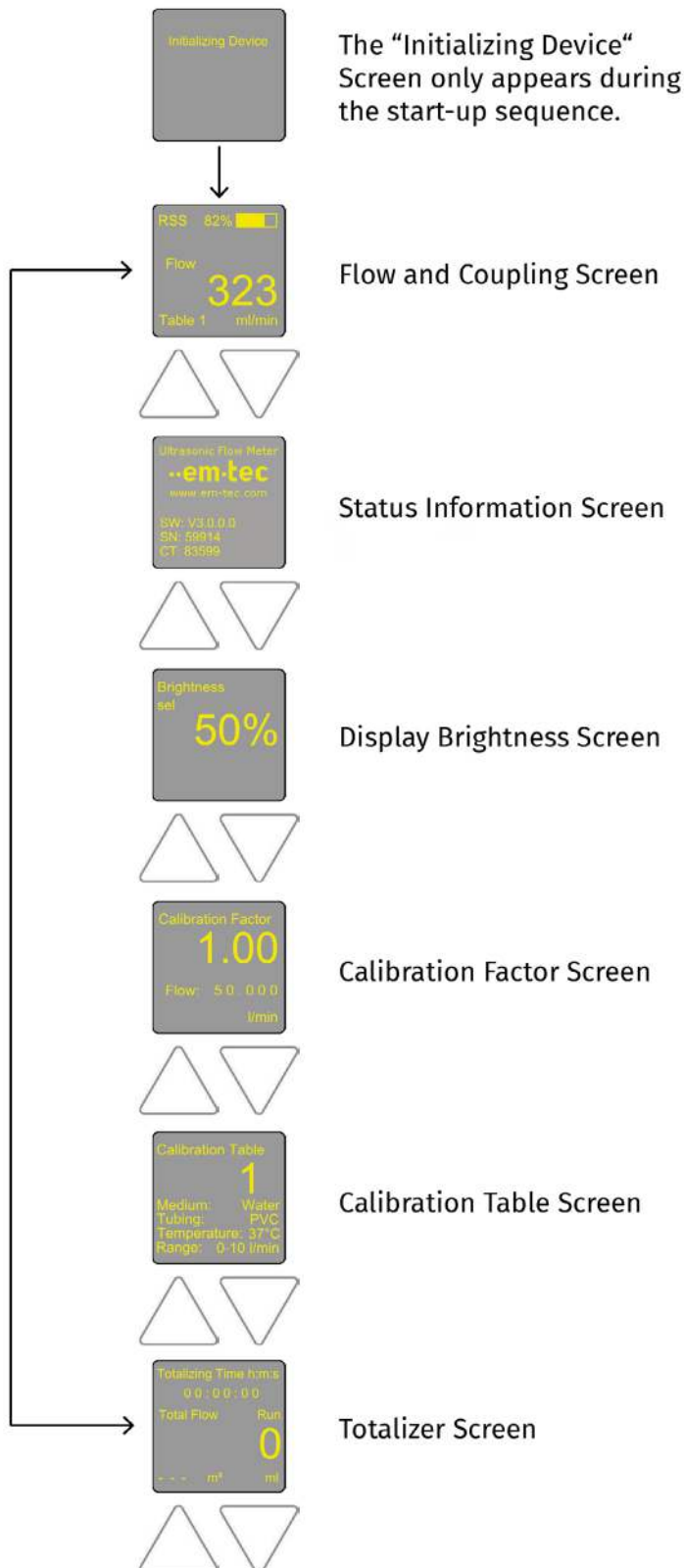

Figure 4: Menu Structure of the BioProTT™ FlowTrack SL

## 6 Installation and Powering of the BioProTT™ FlowTrack SL



- Compliance with the prescribed operating parameters and safety information must be ensured prior to set-up.
- The following installation instructions must be strictly adhered to.

The device is powered on or off by either pushing the switch at the rear of the device when powered via the dedicated power input, or by connecting/disconnecting a DC power supply via one of the analog interfaces (on/off switch is not active in that case).

The BioProTT™ FlowTrack SL works with DC power, which can be supplied by

- the power supply unit shipped with the system using the power socket
- or
- an external 24 V DC ( $\pm 10\%$ ) power supply which delivers at least 300 mA and is continuously short-circuit protected.
- DC power can be supplied either through PIN 1/3 of the power, flow, or RSS socket on the BioProTT™ FlowTrack SL (also see figure 12 in [chapter 13](#)).

**Please note:**

- ⇒ This option is e.g. useful when connecting it to a process control and centrally switching the devices on or off.
- ⇒ In case power is provided via the flow or RSS socket, the on/off button is no longer "active", i.e. the BioProTT™ FlowTrack SL will start up as soon as power is available. In case of a device error, the power supply must be turned off.



- When power is supplied via the power socket, the on/off button is used to power on the BioProTT™ FlowTrack SL, otherwise the on/off button does not have an effect.
- Ensure that there are no conflicting power sources/voltages applied to Pin 1 and Pin 3 on either the power, flow, or RSS socket, as they are internally bridged between the sockets.

### Powering the BioProTT™ FlowTrack SL Using the Power Supply Unit:

To power the device using the included power supply, follow the steps listed below:

1. Connect the power supply unit the device was shipped with.
  - First, attach the respective adapter to the power supply. This can be done by simply clicking the two parts together.
  - Once the adapter is attached, connect the power supply to the rear end of the BioProTT™ FlowTrack SL (see no. 2 in the table in chapter 5.1 "[Rear Panel of the BioProTT™ FlowTrack SL](#)").

**Please note:**

The screw connection should be tight to ensure a stable power supply and to avoid any disruptions of the measurement.

- Plug in the power supply.
2. If needed, connect the 4-20 mA and/or the digital serial output to your data acquisition system. The connectors should be tightened firmly. Unused connector sockets should be covered with the provided flexible grip caps in order to maintain the IP classification.

- Power the device by using the switch. Wait several seconds for the initialization, which is finished once the flow screen appears. The system will automatically start to transfer measurement values. **Please note:** The current loops can either be powered through the process control system or by the BioProTT™ FlowTrack SL. The wiring needs to be done as shown in [chapter 13](#).

### Powering the BioProTT™ FlowTrack SL Over the Analog Socket

To power the BioProTT™ FlowTrack SL over the analog socket, connect the plug of the analog cable to the connection at the rear of the device. Below, the pin assignments and cable colors for flow meters with round connectors for power, flow, and RSS sockets are shown.

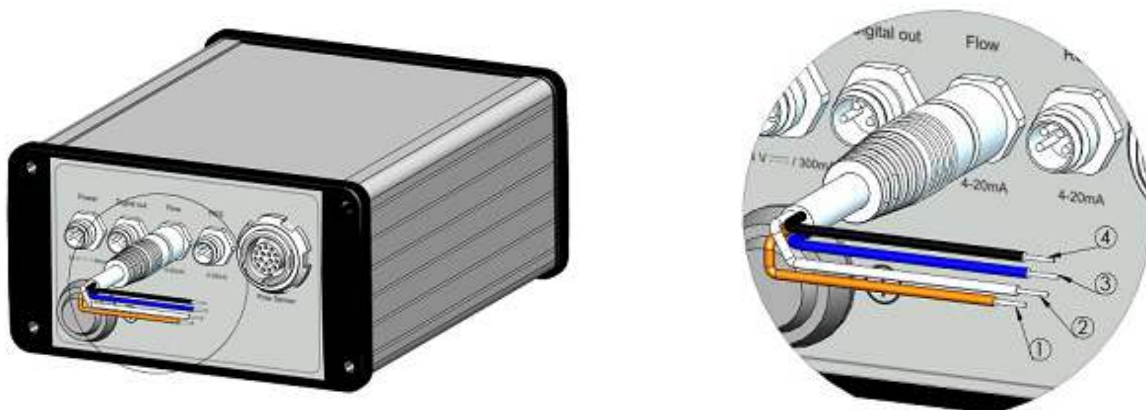

Figure 5: BioProTT™ FlowTrack SL rear view with one analog plug connected (example with flow socket)

Pin No.	Signal Power	Signal Flow/RSS	Wire Color (in supplied cabling)
1	24 V (24V_in)	24 V (24V_in)	brown
2	not assigned	current loop +	white
3	ground in (GND_in)	ground in (GND_in)	blue
4	not assigned	current loop -	black

Table 7: Pin Description of the Analog Socket

## 7 BioProTT™ Clamp-On SL

### 7.1 Installation of the BioProTT™ Clamp-On SL

For further details concerning the use of the BioProTT™ Clamp-On SL and how to carry out flow measurements, please refer to the respective user manual.

To connect the BioProTT™ Clamp-On SL to the BioProTT™ FlowTrack SL, attach the 16-pin sensor plug to the respective connection at the back of the BioProTT™ FlowTrack SL. To do so, please ensure that the red dots on the plug and the socket line up. Once this is done, the sensor can be clamped onto the tube.



The sensor connector must be dry when plugged in.

### 7.2 Attaching the BioProTT™ Clamp-On SL to the Tube

In order to be able to measure the flow inside the tube, the BioProTT™ Clamp-On SL must be clamped onto the tube.



- Before you clamp on the sensor, make sure that the tube is not deformed, damaged, or dirty.
- Ensure that the tube size used corresponds with the size of the BioProTT™ Clamp-On SL.
- Air in the tube can lead to errors in the measurement or interrupt the ultrasound coupling.
- Ensure that there is no debris or residue in the flow channel of the sensor. If necessary, clean the BioProTT™ Clamp-On SL before inserting the tube into the flow channel.

First, make sure that the arrow on the sensor lid is aligned with the flow direction (positive flow display). Then, to clamp on the BioProTT™ Clamp-On SL, follow the steps illustrated below:

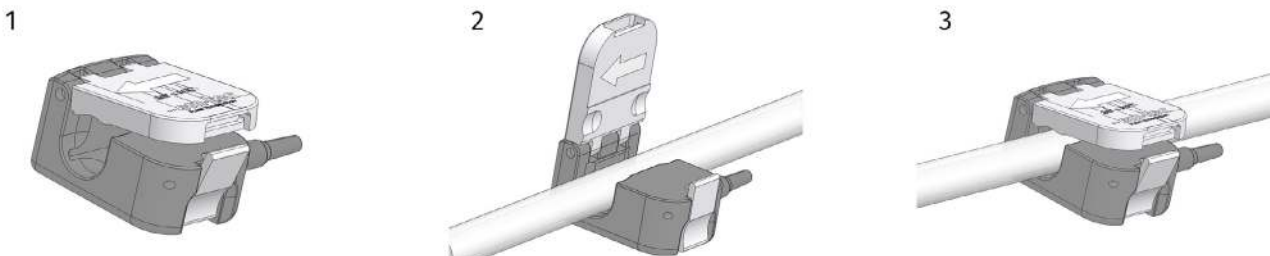

Figure 6: Steps to clamp on the sensor

1. Open the spring-loaded lock and swing back the lid.
2. Insert the tube into the channel.
3. Close the BioProTT™ Clamp-On SL lid and secure it with the help of the spring-loaded lock.



- To avoid flow turbulences and associated measurement inaccuracies, it is necessary for the tube to be straight in the area near the BioProTT™ Clamp-On SL.
- Do not use any excessive force when closing the sensor lid; while the tube should be fixed within the channel, it must not be crammed into it as this might affect the measurement values or damage the sensor.
- Ensure that the lid is fully closed as to avoid fluctuating coupling and flow values.
- Ideally, the tube should be straight for a distance of at least 15 x the inner diameter (ID) of the tube on either side of the sensor.

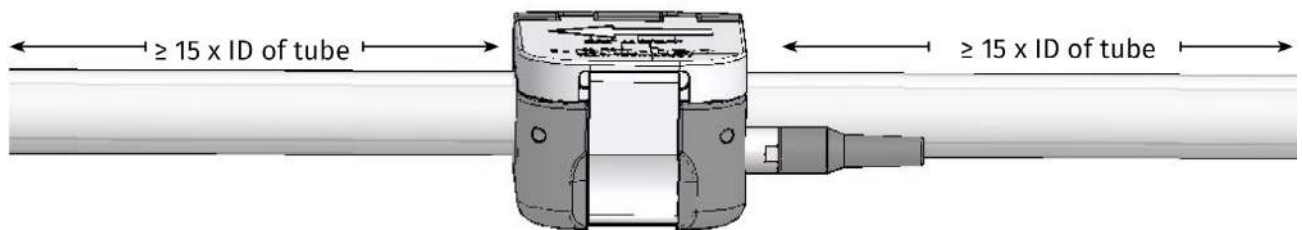

Figure 7: In- and outlet section of the sensor

### 7.3 Use of the BioProTT™ Clamp-On SL



- Make sure to follow the steps described below and to heed the warnings included in them in order to ensure the highest possible accuracy of measurement values.
- If the BioProTT™ Clamp-On SL is not used as intended, the user may be exposed to risks that were not taken into account during its development.
- Before installing the BioProTT™ Clamp-On SL, make sure that there is no dirt or residue in the flow channel as this might affect the coupling and therefore the measurement.
  - For more information regarding the cleaning and disinfection of the BioProTT™ Clamp-On SL, refer to the respective user manual.
- While installing the BioProTT™ Clamp-On SL, be sure not to impair the function of the tubing system.
- For the installation, all ambient conditions must meet the prescribed specifications (see chapter 17 "[Technical Specifications of the BioProTT™ FlowTrack SL](#)" and the data sheet of the compatible sensors, which is available [here](#)).

#### Before starting the flow measurement:

1. Make sure that only tubes specified for the BioProTT™ Clamp-On SL are used as this is the tube type the BioProTT™ Clamp-On SL is adjusted and calibrated for.
2. Before each measurement, the cables, connectors and pins must be checked for breaks or damages as this could result in wrong measurements.
3. Ensure that the temperature of the medium is the same as the one the BioProTT™ Clamp-On SL was adjusted and calibrated for.
4. Ensure that no air bubbles are in the tube during the zero flow adjustment. Allow sufficient time (ca. 5 - 10 minutes) for the system to adapt to ambient conditions, then zero the flow. Only then is the system ready for measurement.

5. The coupling must be checked before each measurement and must be  $\geq 50$  %.
6. A zero flow adjustment must be carried out before each measurement to avoid possible offsets from the measured values.

For the zero flow adjustment,

- the sensor must be clamped in the correct installation position at the location intended for it.
  - the tube must be filled with liquid (i.e. the coupling must be  $\geq 50$  %), but the liquid must not move.
  - ensure that no air bubbles are in the tube.
  - allow sufficient time for the system to adapt to ambient conditions.
- Only then is the system ready for measurement.

**During the flow measurement:**

- Ensure that the coupling is within the operating range of 50 - 100 %. If the coupling falls below 60%, the BioProTT™ FlowTrack SL will not display a flow value.
- The stated measurement accuracy of the BioProTT™ Clamp-On SL is only valid if the specified tubes are used at the specified medium temperature the sensor was adjusted and calibrated for and if the recommended outlet section is respected.
- Any changes in the medium itself or its temperature can cause errors or anomalies in the measurement.
- It must be ensured that the same parameters are used on-site as were used during the adjustment and calibration process.
- While it is possible to carry out measurements outside of the specified flow range, em-tec GmbH cannot guarantee that resulting flow values will be within the given accuracy range.

The parameters of the connected BioProTT™ Clamp-On SL and the selected calibration table are shown on the display of the BioProTT™ FlowTrack SL under the menu item "Calibration Table".

## 7.4 Disassembly and Storage of the BioProTT™ Clamp-On SL



In order to not impair the measurement, it is best to disassemble the BioProTT™ Clamp-On SL once the measurement process has been completed.

To disconnect the BioProTT™ Clamp-On SL, follow these steps:

1. Open the spring-loaded lock and swing back the lid.
2. Remove the tube from the channel.
3. Close the lid and pull the plug out of the evaluation device.

**Please note:**

Only pull lightly on the sleeve of the sensor plug and make sure not to twist so the pins are not damaged.

Once you have disconnected the BioProTT™ Clamp-On SL, check for any residue of the medium or any other kind of dirt or grime and clean the sensor if necessary. Store the sensor according to storage specifications. Make sure to store it in a place where it cannot fall off or be dropped and ensure that the plug is dry.

## 7.5 Exchanging the BioProTT™ Clamp-On SL

If the BioProTT™ Clamp-On SL was exchanged before switching on the evaluation device, the new calibration parameters will be shown on the display of the BioProTT™ FlowTrack SL after the next start-up sequence. If the BioProTT™ Clamp-On SL is exchanged during operation, the alarm is activated with an error message. Once the new BioProTT™ Clamp-On SL is connected, the alarm is reset and the calibration data can be seen on the display.



- Make sure that the BioProTT™ Clamp-On SL is attached at a different place on the tube each time to avoid deformation.
- Ensure that the calibration table used is the one needed for your respective application.

## 8 Adjustment and Calibration of the BioProTT™ Clamp-On SL

In order to ensure the highest possible accuracy, all BioProTT™ Clamp-On SLs are adjusted according to customer specifications in regard to the relevant parameters prior to shipment.

If any of these parameters change, it is possible to send the sensors in for a re-adjustment.

In addition, em-tec GmbH recommends regular calibrations to be carried out. A rule of thumb would be every 24 months. Other than the adjustment, the calibration can be carried out by the customer on site.

For more information regarding this process, you can read and download our TechNote "Adjustment vs. Calibration" on our website. It is, of course, also possible to send the sensor to em-tec GmbH so we can carry out the calibration.



## 9 General Settings and Functions of the BioProTT™ FlowTrack SL

The BioProTT™ FlowTrack SL is equipped with a display and the following functions are available via the graphical user interface (GUI).

**Please note:** The screens shown are mere examples.



When the display is used but settings (e.g. calibration table, calibration factor) are changed via the digital interface at the same time, the changes carried out over the digital interface will only be visible on the display when the specific screen is "flashed", meaning if the user changes to another screen and back.

The measurement, however, will be immediately affected by the changed setting.

### 9.1 Screen Saver

The BioProTT™ FlowTrack SL is equipped with a screen saver for the display. The screen saver is activated automatically after a time of 30 minutes if no user action has taken place.

With the activation of the screen saver, the display brightness is set to the minimum value of 25 % and the em-tec logo rotates on the screen.

It is possible to deactivate the screen saver and return to the screen that was displayed last by using either of the arrow buttons.

**Please note:**

If the arrow buttons are pressed at the same time as the enter or zero button, the screen saver is still active.

### 9.2 Adjustment of Brightness

It is possible to adjust the display brightness as follows:



Screen	Meaning
	<p>The default value is set at 50% brightness. It is possible to set the value to 25, 50, 75, and 100%.</p> <p>By pressing the enter  button, the menu is activated.</p> <p>By indicating "sel", the user can select the value using the arrow  buttons.</p> <p>Repeated pressing of the enter button stores the selected value.</p>

Table 8: Brightness Screen

## 9.3 Flow Value and Coupling

The flow value and coupling are displayed as follows:

Screen	Meaning
	<p>The flow value is calculated using the selected calibration table and calibration factor.</p> <p>When the flow value is greater than <math>\pm 999</math> ml/min, the units displayed are changed to l/min.</p> <p>In order to adjust the "zero" offset, please ensure that there is sufficient coupling and no flow in the tubing before pressing the "zero" button on the device until the flow value is set to zero.</p>
	<p>The Received Signal Strength (RSS) of the ultrasonic signal is an indication of the ultrasonic signal transmission quality through liquid, tubing, and sensor. Consequently, the RSS signal indicates the acoustic coupling. A sufficient acoustic coupling is a prerequisite for accurate measurements.</p> <p>The current RSS value is shown if a sensor is connected. If the coupling becomes insufficient (&lt;50 %), the flow value will be blanked out.</p> <p>For details, see chapter 10.2.1 "<a href="#">Received Signal Strength (RSS/Acousting Coupling</a>" on the Analog Interface").</p>

Table 9: Flow and Coupling Screen



- In order to ensure the highest possible acoustic coupling, make sure that the correct calibration table is selected (i.e. that the table's parameters mirror the parameters of your application).
- As a low or insufficient RSS value can negatively influence the measurement, the flow value is blanked out when the acoustic coupling falls below 50 %.

## 9.4 Selection of a Calibration Table

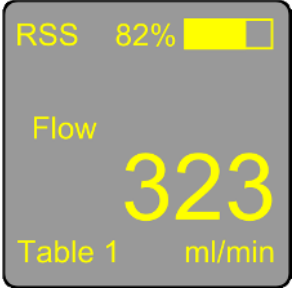
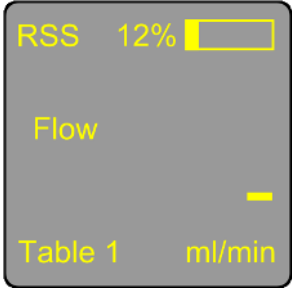
Each BioProTT™ Clamp-On SL can hold up to seven calibration tables, which can be selected via the appropriate screen by using the Arrow and Enter buttons.

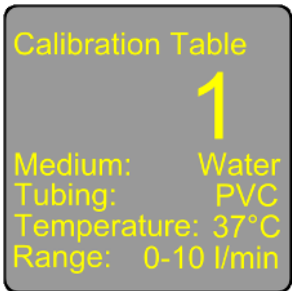
Screen	Meaning
	<p>The calibration table screen can be accessed only when a valid sensor is connected.</p> <p>The calibration table is linked to the sensor. When the device is powered on/off, and/or the sensor is changed or reconnected, the table is reset to Table 1.</p> <p>Selecting a different calibration table does not change the calibration factor.</p>



Screen	Meaning
	<p>When selecting a new table, "sel" appears on the screen. Please confirm the new selection with the enter  button.</p> <p>If the calibration table is changed, make sure to zero the system at zero flow to ensure an optimal measurement accuracy.</p> <p>→ Please also ensure that the actual system set-up and the calibration parameters shown in the table are matching as inaccurate readings might occur otherwise.</p> <p>The upper value of the range indicates the Qmax of the selected table.</p>

Table 10: Calibration Table Screen of the BioProTT™ FlowTrack SL

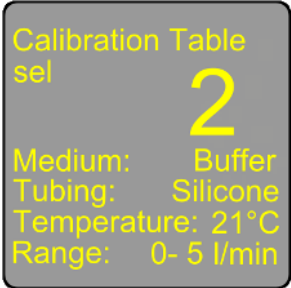

Always ensure that the selected calibration table is the one needed for your application.

## 9.5 Totalizing

There is a built-in flow totalizer available via the following screen:



Screen	Meaning
	<p>The totalizer screen can only be accessed when a valid sensor is connected.</p> <p>When entering the totalizing screen, the initial zero elapsed time and the total flow value are shown.</p>
	<p>After the totalizing has been started with the enter  button, the totalizer indicates "Hold" and shows the elapsed time as well as the total flow value in the units shown on the screen.</p>
	<p>If the coupling is insufficient, or a sensor table has been selected, an exclamation mark appears. This indicates that the displayed totalized volume can differ from the real total flow due to changes in the liquid or the calibration.</p>

Table 11: Calibration Table Screen of the BioProTT™ FlowTrack SL

- The total flow is displayed in milliliter [ml] with three digits when the value is below one liter (<1 l).
  - When the value is  $\geq 1$  l, the unit is changed to liter [l]. In this case, the maximum displayed total flow is 999.9 liter, whereas the digit stating the ml-value is the one after the full stop.
  - When the sum exceeds a value of 999.9 liters, the lower left corner shows 1 m<sup>3</sup> and the totalizer will continue to operate.
  - The maximum digits for the m<sup>3</sup> counter is three digits, which corresponds to a maximum of 999 m<sup>3</sup>.
- The totalizer has two limits. Either a totalizing time of 999:59:59 hours (approximately six weeks) or a totalized flow of 999 m<sup>3</sup> or 999.9 l.
  - Whenever one of these limits is reached, the totalizer is stopped and the string "OVR" (=Overrun") is shown on the display.
  - The values for Totalizing Time and Total Flow are held and shown on the display until the user resets the totalizer, turns off the power, or disconnects the sensor.
- When entering the totalizer screen, the screen shows:
  - "Hold", when the totalizer is running
  - "Run", when the totalizer has not been started, yet, or when the totalizer was stopped.

By pressing the enter button, the user is able to start/stop the totalizer. Entering other menus of the device while the totalizer is running will not have an effect on the totalizer.
- When the totalizer is running and the enter button is pressed, the totalizer is stopped. The display will show the value for the total flow at this point and indicate "Run" status.
- Pressing the enter button again will resume the totalizing process, starting with the Totalizing Time and Total Flow before stopping. Additionally, the Totalizing Time value will stop flashing.
- While in the totalizer menu, the totalizer is reset by pressing the Zero/Reset button. The resetting can be performed while the totalizer is in the Hold or Run status. When the totalizer is reset during run, it continues working, starting with a zero value.

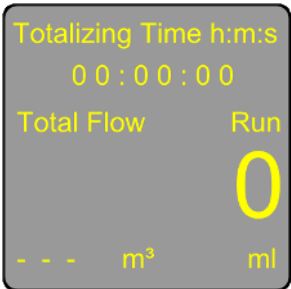
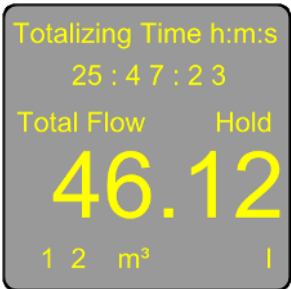

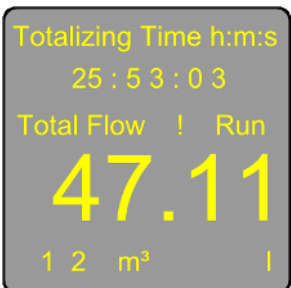
- 
- In case of insufficient coupling (<50 %) during the run of the totalizer, an exclamation mark is shown next to the string "Total Flow" (Indication for the user).
  - While the coupling is insufficient, the Totalizing Time is stopped and the Total Flow value is not changed (no further summation).
  - If the coupling increases back to  $\geq 50$  % (e.g. after a bubble has passed), the totalizing process resumes with the values of before the drop in coupling occurred. The exclamation mark will stay on the screen until zero is pressed.
  - If a sensor is disconnected during the totalizer run, the data is deleted.
  - **Please note** that the totalizer information is not transferred through the RS-232 interface.
-

## 9.6 Setting a Calibration Factor

It is possible to adjust the calibration factor to accommodate changes in your application parameters such as a different medium or medium temperature when compared to the calibration settings of the connected BioProTT™ Clamp-On SL.

The calibration factor can be adjusted in the range of 0.50 to 1.50 in steps of 0.01.



Screen	Meaning
	<p>The calibration factor screen can be accessed only when a valid sensor is connected.</p> <p>On the calibration screen, the actual flow value is shown.</p> <p><b>Please note:</b></p> <ul style="list-style-type: none"> <li>- The default setting for the calibration factor is 1.00.</li> <li>- The calibration factor is connected to the sensor, meaning that when the device is powered on/off, and/or the sensor is changed or reconnected, the factor is automatically reset to 1.00.</li> </ul>
	<p>By pressing the Enter and using the Arrow buttons, the factor can be changed. Pressing the Enter button again will store the value.</p> <p><b>Please note:</b></p> <p>Changing the calibration factor will instantly affect the flow values displayed on the screen and on the digital and analog interface.</p> <p>→ Consequently, changes can be observed directly at the indicated flow displayed below the set calibration factor.</p>

Table 12: Calibration Factor Screen

For more information regarding the calibration factor and how to determine it, read and download our [TechNote "Determining the Calibration Factor"](#).

## 10 Flow Measurement with the BioProTT™ FlowTrack SL

**Before starting the flow measurement, there are a few things to keep in mind:**

As ultrasound is reflected by gaseous and solid particles, the flow reading can be inaccurate when there are bubbles within the system. Bubbles can be detected by observing the coupling value. This value is either fluctuating (small bubbles) or constantly low during the passage of larger bubbles or foam. To avoid inaccurate readings, there is no flow displayed when the coupling values are insufficient, i.e. below 50 %. Once the coupling reaches values above 50 %, the flow is displayed again.



- Please keep in mind that the flow values are averaged values.  
 → It is therefore recommended to ignore the flow values displayed within the first 1-2 seconds after the coupling has increased beyond 50 %.
- This is especially the case for the 10 second mean flow transmitted by the serial interface where it can take up to 10 seconds to average out the effect.
- Since the BioProTT™ FlowMeasurement System has no "insufficient coupling status storage hold time" and no "measurement error ignore time", assessment and handling of the flow values after recovery of a drop in RSS value must be performed by the user according to the needs and requirements of the application.

### 10.1 Flow Measurement Using the Digital Interface

#### 10.1.1 Pin Assignment and Cable Colors for the Round Connector to the Digital Interface

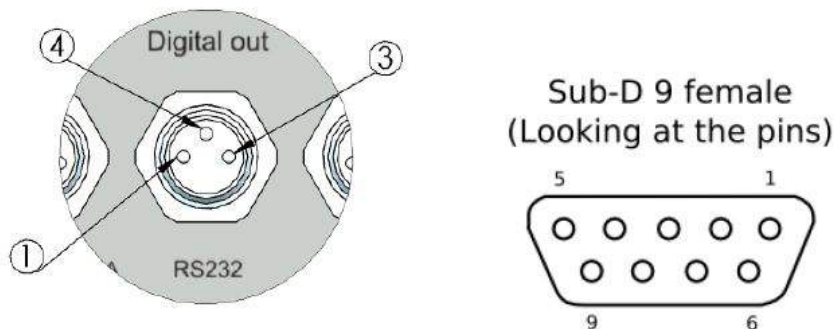

Figure 8: Pin Assignment of the Digital Output

PIN No.	Signal	Sub-D Connector	Wire Color (in supplied cabling)
1	PC_TXD	PIN 3	brown
3	GND	PIN 5	blue
4	PC_RXD	PIN 2	black

Table 13: Pin Description of the Digital Socket

### 10.1.2 Pin Assignment and Cable Colors for the Round Connectors to the Power, Flow, and RSS Interface



The circular plug design optimally supports the flow measurement application. Connecting the device to devices or sensors it is not intended as it can lead to damage.

**Please note:** Unused connector sockets should be covered with the provided flexible grip caps. For additional protection, it is recommended to use suitable screw caps for all sockets that are not connected or used.

### 10.1.3 Using the Digital Interface

Via the asynchronous serial communication port, the BioProTT™ FlowTrack SL can communicate with a host system. The interface must be initialized to the following parameters:

- Baud rate: 38,400 Baud
- Bits: 8 data bits
- Start Bit: 1
- Stop Bit: 1
- Parity: No
- No hardware (CTS/RTS) or software (Xon/Xoff) handshake

The data transmission runs without any request from the host system. The following commands are available via the digital interface. Every command has to be sent with carriage return <CR>.

The recommended delay between two commands should not be less than 1 second.

Command	Meaning
I <CR>	Idle (stop communication)
R <CR>	Restart (restart communication)
Z <CR>	Zero Adjustment
S <CR>	<p>Sensor and Device Status Information Request: The sensor and device status information consist of an ASCII data text string with the following information:</p> <ul style="list-style-type: none"> <li>- sensor serial number (16 bytes)</li> <li>- tube size of the sensor (16 bytes)</li> <li>- blank delimiter</li> <li>- tube type of selected calibration table (16 bytes)</li> <li>- blank delimiter</li> <li>- medium of selected calibration table (8 bytes)</li> <li>- temperature of the selected calibration table (6 bytes)</li> <li>- blank delimiter</li> <li>- number of calibration tables (6 bytes)</li> <li>- Qmax of the selected calibration table (8 bytes)</li> <li>- &lt;CR&gt; and &lt;LF&gt;</li> <li>- flow meter serial number (16 bytes)</li> <li>- blank delimiter</li> <li>- SW-version number (16 bytes)</li> <li>- the data string is finished by &lt;CR&gt; and &lt;LF&gt;</li> </ul>

Command	Meaning
T1 <CR>....T7 <CR>	Request to set/use calibration table number 1...7 <b>Please note:</b> If requesting a non-existing table (e.g. selecting table number 7 if there are only five tables stored) the table will not change.
Cx.yz <CR>	set calibration factor (values between 0.50 and 1.50 with two decimal digits, e.g. C1.10<CR>)

Table 14: Commands for digital interface of the BioProTT™FlowTrack SL

The digital interface transmits the following ASCII data string every 100 ms (10 Hz):

**ee\_ss\_aaa\_p.pp\_ffffff\_mmmmmm\_ssssss\_tttttt\_<CR><LF>**

### Meaning of the Different Bytes:

Byte	Meaning	Remark
ee	hexadecimal error message according to separate table in chapter 14 " <a href="#">Error Code Information for the BioProTT™ FlowTrack SL</a> " 00 means no error is present	
"_"	blank delimiter between the different parameters (hex 0x20)	Underscore is only used to represent blank
ss	hexadecimal status information see chapter 11 " <a href="#">Status Information</a> " for more details	
aaa	acoustic coupling/ RSS in %; range 0 to 100%	
p.pp	calibration factor	
ffffff	mean flow calculated over 100 ms (output rate of 10 Hz) in ASCII (range: -999999 ml/min to +999999 ml/min) including calibration factor	Note*
mmmmm	mean flow calculated over 1 s (output rate of 1 Hz) in ASCII (range: -999999 ml/min to +999999 ml/min) with calibration factor applied	Note*
sssss	mean flow calculated over 10 s (output rate of 0.1 Hz) in ASCII (range: -999999 ml/min to +999999 ml/min) including calibration factor	Note*
ttttt	board temperature in °C (38 = 38°C)	
<CR>	0x0d Carriage Return	
<LF>	0x0a Line Feed	

Table 15: Output of digital interface of the BioProTT™ FlowTrack SL

**\*Note:** Beside numerical values, these strings contain the following characters:

- "-", a minus symbol is used for negative values or to indicate blanked out values (character hex "0x2D")
- "^", indicating overflow condition (character hex: "0x5E")
- "v"; indicating underflow condition (character hex: 0x76")



**Please note:** If your own applications are programmed, both error and status byte must be evaluated for a proper system assessment.

In case of flow distortions, e.g. bubbles, the mean flow values may be affected.



Ensure that the serial interface parameters are set correctly and that no invalid letters are sent as this can possibly lead to a hang-up of the system, which then requires a restart of the system by powering off.

Below are some examples of output strings to help better understand the interface. All strings are terminated with <CR> (=carriage return) <LF> (=linefeed) and are shown below between quotation marks ("). These output strings are transmitted periodically every 10 Hz.

- **Sensor working correctly, calibration factor 0.99, table 1**  
"00 00 100 0.99 7195 7193 6897 +41" <CR><LF>
- **Sensor working correctly, calibration factor 1.00 table 2, with negative flow values**  
"00 04 100 1.00 -3588 -3590 -3589 +43" <CR><LF>
- **Sensor working correctly, calibration factor 1.34 table 2, with negative flow values**  
"00 04 100 1.34 -4804 -4805 -4805 +43" <CR><LF>
- **Sensor connected, after stable zeroing**  
"00 40 100 1.00 0 0 0 +43" <CR><LF>
- **Sensor connected, insufficient acoustic coupling/RSS value**  
"00 24 34 0.99 ----- +43" <CR><LF>
- **Sensor connected, over temperature error 77°C on PCB inside device (data blanked out)**  
"1A 41 --- ---- ----- +77" <CR><LF>
- **Flow out of range condition: Flow exceeds +999999 ml/min; Cal\_factor 1.01;**  
"00 40 75 1.01 ^^^^^^ ^^^^^^ ^^^^^^ +29" <CR><LF>
- **Flow out of range condition: Flow exceeds -999.999 ml/min; Cal\_factor 1.50;**  
"00 40 89 1.50 vvvvvvv vvvvvvv vvvvvvv +29" <CR><LF>
- **Sensor disconnected**  
"00 E0 --- ---- ----- +35" <CR><LF>

### Response to Serial Commands

- **Changing the calibration table (in sensors with more than one table) from table 1 to table 2 by command "T2"<CR>. The status bit changes from 44 to 40. Due to clearance of averaging storage, the first 3 strings are blanked**

```
"00 44 100 1.00 0 0 0 +41" <CR><LF>
"00 44 100 1.00 0 0 0 +41" <CR><LF>
"00 60 0 1.00 ----- +41" <CR><LF>
"00 60 0 1.00 ----- +41" <CR><LF>
"00 60 0 1.00 ----- +41" <CR><LF>
"00 40 100 1.00 2 0 0 +41" <CR><LF>
"00 40 100 1.00 2 43 67 +41" <CR><LF>
"00 40 100 1.00 3 36 67 +41" <CR><LF>
```

- Request for status information "S"<CR> when sensor is connected

```
"83599          3/8" x 3/32"          PVC          Blood
37             °C      6             10000"        <CR><LF>
"59915          V3.0.0.0             " <CR><LF>
```

The sensor information above corresponds to the currently selected calibration table and the first line reads as follows:

83599	= Serial Number of Sensor
3/8" x 3/32"	= Tube Size
PVC	= Tube Material of Selected Table
Blood	= Calibration Medium of Selected Table
37°C	= Calibration Temperature of Selected Table
6	= Number of Calibration Tables Stored on the Sensor
10000	= Flow Range of Selected Calibration Table (Qmax)

The device information in the second line contains:

59915	= Serial Number of BioProTT™ FlowTrack SL
V3.0.0.0	= Software Version

- Request for status information "S"<CR><LF> when no sensor is connected

```
"-----"
-----" <CR><LF>
"59915          V3.0.0.0             " <CR><LF>
```

The sensor information in the first line is blanked.

The device information in the second line contains:

59915	= Serial Number of the BioProTT™ FlowTrack SL
V3.0.0.0	= Software Version

## 10.2 Flow Measurement Using the Analog Interface

The BioProTT™ FlowTrack SL can be connected to data acquisition or process control systems via the analog interface. There are two analog interfaces to transmit the flow and the RSS (acoustic coupling) values. The values are transmitted within the range of 4 - 20 mA.

### 10.2.1 Received Signal Strength (RSS/Acoustic Coupling) on the Analog Interface

The software maps the RSS value from 0 - 100% to 4 - 20 mA in a linear way. The current output of the RSS value can be interpreted as follows:

- 0 mA indicates a broken cable, circuit, or power outage.
- currents between >0 mA and 1 mA indicate an error or invalid sensor.
  - It is also possible that the sensor wasn't (yet) recognized.
- 4 mA equals 0 % coupling/ RSS (or no signal)
- 20 mA equals 100 % coupling/ RSS (excellent signal)

The RSS value should be at least 60 % or 12 mA respectively. This indicates a good signal and will ensure accurate flow measurements.



- If the tube is too small or if the sensor is too large, it can impair the coupling.
- If there is no liquid or if there are bubbles inside the tube, it can impair the coupling.
- Ensure that the tube is the one the sensor was calibrated for.
- When attaching the sensor to the tube, make sure to follow the instructions in the chapter 7.1 "[Installation of the BioProTT™ Clamp-On SL](#)".

### 10.2.2 Flow Value on the Analog Interface

The analog interface consists of a 4-20 mA current loop. Make sure that the voltage supply for the current loop is 24 V DC.

The current output of the device for flow can be interpreted in the following way:

- 0 mA indicates a power outage or a broken cable or circuit
- >0 mA to 1 mA indicate invalid flow conditions, e.g. low coupling or an error condition such as an invalid sensor or a sensor that has not been recognized
- 1 mA to 4 mA corresponds to a negative flow, with 1 mA corresponding to the negative flow value applying the same gradient as with the positive flow values.
  - This means the mapping of the negative flow into a current value is truncated at 1 mA.
  - The 1 mA value corresponds to a negative flow of 28% of the nominal flow range of the calibration table.
- 4 mA equals a zero flow, with proper offset correction (sensor offset zeroed)
- 20 mA corresponds to the 1.5 x maximum nominal flow Q<sub>max</sub> of the selected calibration table of the connected sensor.
  - See the table below for the calculation of the specific conversion factors that must be applied.
- >20 mA to 23 mA indicate a flow outside the nominal or extended range

The figure below shows the flow rate versus the output current for a sensor with a standard flow range of 10,000 ml/min. The conversion of a flow to a current is scaled to the Qmax in the sensor table.

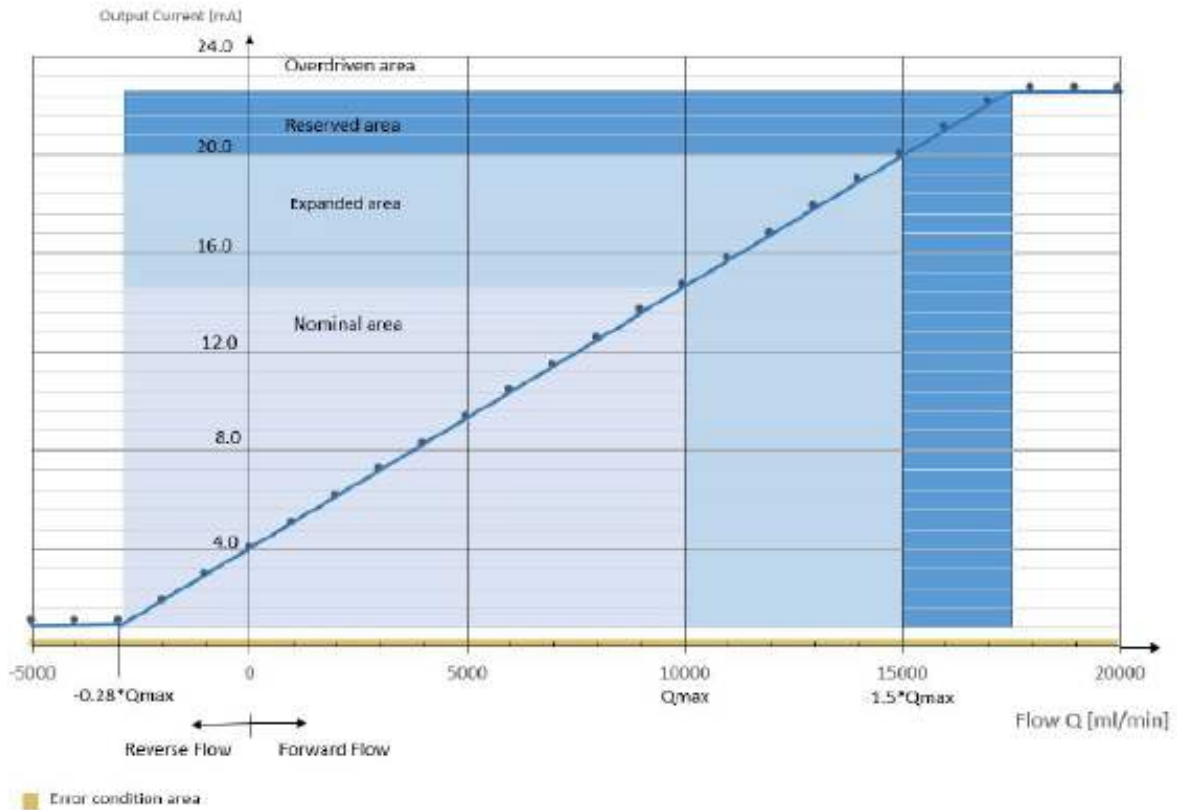

Figure 9: Flow rate vs. output current for a sensor with a flow range of 10,000 ml/min

To calculate an output current into the flow value (with adjusted calibration factor accounted for), use the following equation:

$$\text{Flow [ml/min]} = (\text{Current Output [mA]} - 4 \text{ mA}) \times \text{Analog Current Conversion Factor}$$

The analog current conversion factor depends on Qmax of the selected sensor table. This value is indicated in the calibration report, shown as range on the display, or given on the serial port.

→ The Qmax related to analog current conversion factors are indicated in the table below.

To calculate an output current into the "original" flow value as the system is measuring it (without adjusted calibration factor), use the following equation:

$$\text{Flow [ml/min]} = (\text{Current Output [mA]} - 4 \text{ mA}) \times \frac{\text{Analog Current Conversion Factor (max. flow range)}}{\text{Calibration Factor}}$$

The current conversion factors as well as the maximum reverse flow for different Q<sub>max</sub> for the analog flow output are listed in the following:

Standard flow Q <sub>max</sub> [ml/min] for a calibration factor of 1.00	Analog Current conversion factor [(ml/min) / mA]	Max. reverse flow [ml/min] at 1 mA
4000	375	-1125
6000	562,5	-1688
8000	750	-2250
10000	937,5	-2813
20000	1875	-5625
50000	4687,5	-14063
100000	9375	-28125

Table 16: Range and Conversion Factors for the Analog Interface of the BioProTT™ FlowTrack SL

**Please note:**

- The conversion factor is a **fixed** value based on the maximum flow range of a sensor table when the calibration factor is set to 1.50.
- It is **not** dependent on the actual chosen calibration factor.
- The conversion factor is calculated as follows:

$$\begin{aligned} \text{Analog Current Conversion Factor} &= (\text{max. Calibration Factor}) \times \frac{Q_{\text{max}} [\text{ml}/\text{min}]}{\text{Current max} [\text{mA}] - 4 \text{ mA}} \\ &= 1.5 \times \frac{Q_{\text{max}} [\text{ml}]}{16 [\text{min} \times \text{mA}]} \end{aligned}$$

## 11 Status Information

The following status information is provided via the interfaces:

Description	Digital Interface RS-232 Status Byte "ss"*	Display	Measures (see also chapter 15 <a href="#">"Troubleshooting"</a> )
Sensor disconnected	Bit 7 = 1	Flow screen shows "-" RSS shown	Connect sensor. Check cable.
Set if uncalibrated transit time difference value between -3.000 and +3.000	Bit 6 = 1	Flow value RSS value	None
Insufficient Coupling (RSS <50 %)	Bit 5 = 1	Flow screen shows "-" RSS value	Check coupling.
Selection of calibration table	Bit 4, 3, 2 are set according to selected calibration table	Selected table shown on screen	None. Check if correct table is selected.
Flow invalid	Bit 1 = 1	Flow screen shows "-" RSS value	Check coupling.
Temperature too high	Bit 0 = 1	Flow screen shows "-" RSS value	See <a href="#">Troubleshooting</a> .

Table 17: Status Information

\*Bit value is converted into a hexadecimal value when transmitted with a string over the digital interface.

## 12 Cleaning and Disinfection

### 12.1 Cleaning and Disinfection of the BioProTT™ FlowTrack SL



Make sure no detergents or disinfectants leak into this device.

The BioProTT™ FlowTrack SL can be cleaned by wiping it with a damp, lint-free cloth and warm water.

For low-level disinfection, an aqueous 70 % isopropanol solution or Bacillol can be used. Additionally, please follow the legal regulations valid in your country and the hygiene regulations for your specific application.



- The BioProTT™ FlowTrack SL may not be submerged into cleaning or disinfecting solution.
- The BioProTT™ FlowTrack SL is not suited for cleaning processes using machines.  
→ Sterilization processes, especially steam sterilization or autoclaving, may not be used.
- Do not use cleaning agents that scratch or that are abrasive and/or corrosive (e.g. scouring powder!)
- The accessories must only be plugged in when dry.
- The accessory connectors must not be immersed in liquid.
- The concentrations and exposure times of the cleaning agents and disinfectants specified by the respective manufacturer must be strictly observed, including material compatibility.

The following surface disinfectant is recommended:

Name	Manufacturer	Contact
Bacillol® AF	Hartmann	www.hartmann.de

### 12.2 Cleaning and Disinfection of the BioProTT™ Clamp-On SL



Make sure no detergents or disinfectants leak into this device—particularly the plug.

For the cleaning of the BioProTT™ Clamp-On SL, we recommend commonly used detergents or the one recommended below. In order to avoid stains and dirt from drying out, any residue should be removed after each application.

To clean the BioProTT™ Clamp-On SL, use a lint-free cloth. Be sure to remove any dirt in the clamping area. Additionally, please follow the legal regulations valid in your country and the hygiene regulations for your specific application.



- The BioProTT™ Clamp-On SL may not be submerged into cleaning or disinfecting solution.
- The BioProTT™ Clamp-On SL is not suited for cleaning processes using machines.  
→ Sterilization processes, especially steam sterilization or autoclaving, may not be used.

The following surface disinfectant is recommended:

Name	Manufacturer	Contact
Bacillol® AF	Hartmann	www.hartmann.de

## 13 Loops for the BioProTT™ FlowTrack SL

### 13.1 Current Loop Definitions for the BioProTT™ FlowTrack SL

Generally, devices in 4 - 20 mA environments can be classified based on the current source of the 4 - 20 mA loop as "active" or "passive". Passive devices or sensors rely on external loop power, whereas active devices are powering the current loop.

With respect to the 2-/4-wire classification of sensors, as a rule of thumb, one can assume that 2-wire sensors are usually working passively, while 4-wire sensors tend to be able to support the signal current loop being passive or active.

The BioProTT™ FlowMeasurement System supports passive and active modes of operation for flow and RSS current loop (see figure below). However, the BioProTT™ FlowTrack SL always needs power in order to operate.

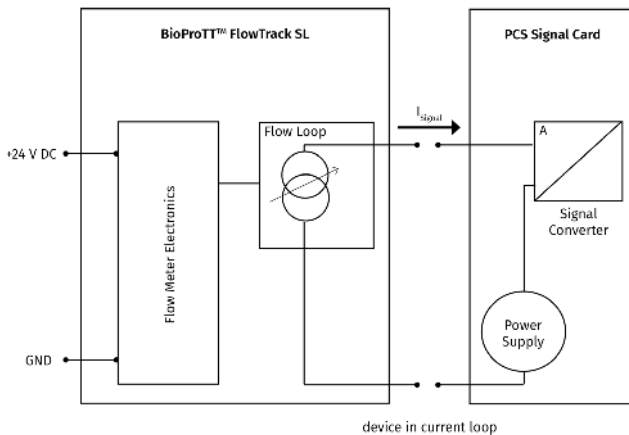

Figure 10: BioProTT™ FlowTrack SL supporting "passive" loop configuration (example: flow)

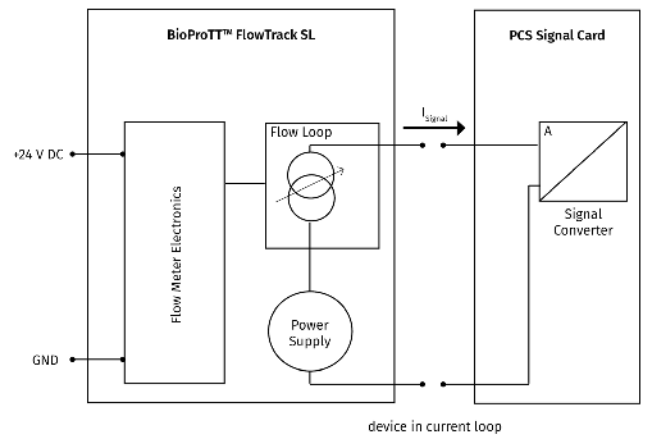

Figure 11: BioProTT™ FlowTrack SL supporting "active" loop configuration (example: flow)

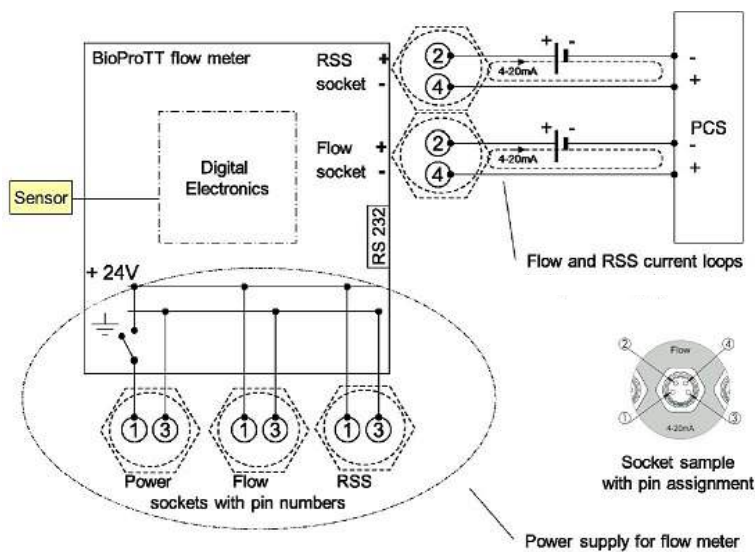

Figure 12: BioProTT™ FlowTrack plus schematics with focus on power supply

In addition, the figure on the left shows wiring alternatives for the BioProTT™ FlowTrack SL, which is important to properly wire the system. The pin assignment corresponds to the pins as outlined in the following chapters.



### 13.2 Checking the Current Loops of the BioProTT™ FlowTrack SL

Current loops (flow or RSS) can be tested with different measurement configurations described in this chapter.



- Please always ensure that a BioProTT™ Clamp-On SL is connected to the flow meter and that there is an actual flow so that a reading is possible in the first place.
- Make sure that the BioProTT™ FlowTrack SL is adequately powered before carrying out any checks.

#### 13.2.1 Method 1: Using Power from the BioProTT™ FlowTrack SL and Measuring with an Amperemeter

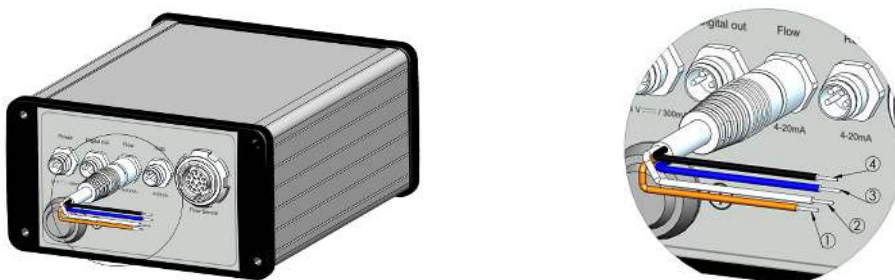

Figure 13: BioProTT™ FlowTrack SL rear view with one analog plug connected (example with RSS socket)

Pin No.	Signal	Connection	Wire Color (in supplied cabling)
1	24 V (24V_in)	Connect Pin 1 with Pin 2	brown
2	Current Loop +	see above	white
3	Ground in (GND_in)	Connect Pin 3 to the appropriate connector of your reading device/data logger, e.g. "return" or "-" of an amperemeter	blue
4	Current Loop -	Connect Pin 4 to the appropriate connector of your reading device/data logger, e.g. "send" or "+" of an amperemeter.	black

Table 18: Wiring for the BioProTT™ FlowTrack SL for loop check with amperemeter

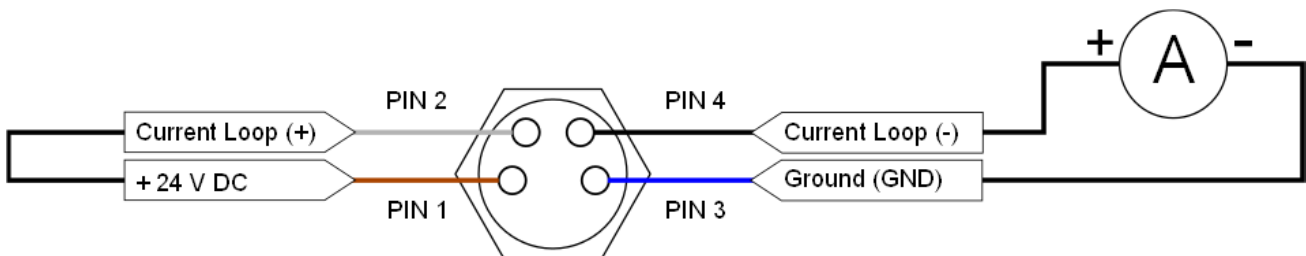

Figure 14: Schematics—Looking at Pins at the Rear of either the Flow or RSS Socket

Tolerances for current measurement (range of amperemeter 0 - 50 mA DC) are as follows:

- max. 1 % + 5 digits within range of >50.000 mA
- internal resistance <10 Ohm

### 13.2.2 Method 2: Providing Power Externally and Measuring with Amperemeter

Pin No.	Signal	Connection	Wire Color (in supplied cabling)
1	24 V (24V_in)	Connect Pin 1 with Pin 2	brown
2	Current Loop +	Connect Pin 2 to "+" of battery/24 V DC power source	white
3	Ground in (GND_in)	Connect Pin 3 to the appropriate connector of your reading device/data logger, e.g. "return" or "-" of an amperemeter.  Close loop by connecting also to "-" of battery.	blue
4	Current Loop -	Connect Pin 4 to the appropriate connector of your reading device/amperemeter, e.g. "send" or "+".	black

Table 19: Wiring for the BioProTT™ FlowTrack SL for loop check with external power

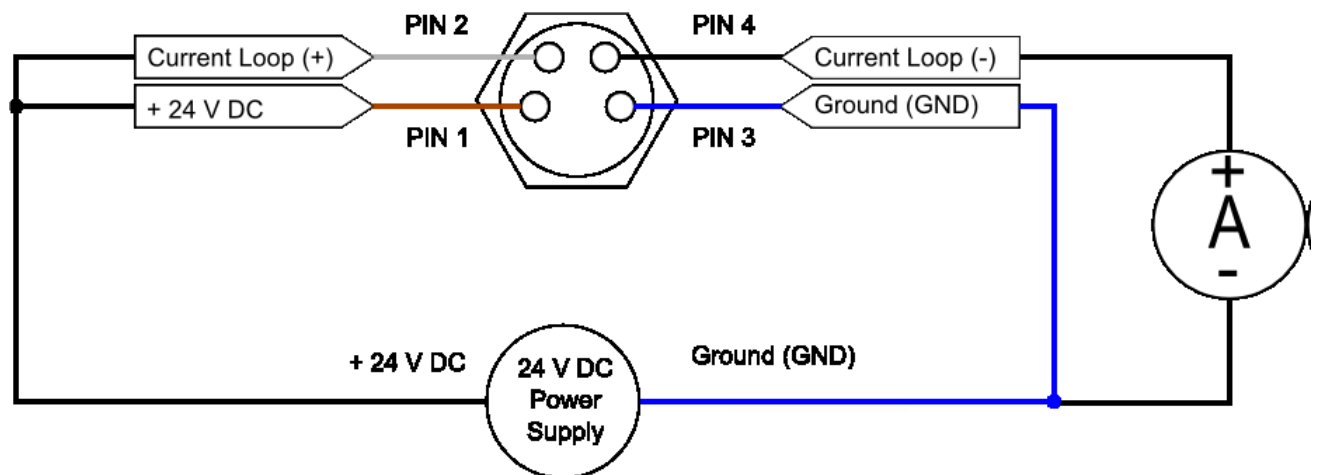

Figure 15: Schematics—Looking at Pins at Rear of either the Flow or the RSS socket

Tolerances for current measurement (range of amperemeter 0 - 20 mA DC) are as follows:

- max. 1% + 5 digits within the range of > 50,000 mA
- internal resistance < 10 Ohm

### 13.2.3 Method 3: Checking Functionality with Voltmeter



- It is also possible to test the functionality of the current loops (Flow or RSS) with a voltmeter. In this case, the resistor must be used.
- Based on Ohm's law, the current through a resistor can be calculated as  $I = V/R$ .
- The loop can be powered either externally or via flow meter as shown in the diagram below.

The table indicates examples of conversion of 0-20 mA signal to voltage.

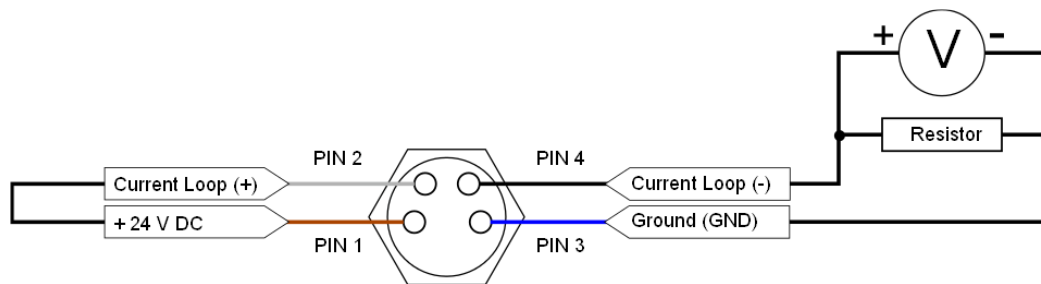

Figure 16: Schematics—Looking at Pins at Rear of either Flow or RSS Socket

Tolerances for current measurement (range of amperemeter 0-20 mA DC) are as follows:

- resistor min. 100 Ohm, max. 600 Ohm
- tolerance of resistor min. 1%, better 0,1%
- internal resistance of voltmeter min. 1MΩ

Conversion Voltage Range	Recommended Measuring Resistance	Current to Voltage Conversion Factor	Zero Point Voltage at 4 mA
0 - 2 V	100 Ohm	0.1 V per mA	0.4 V
0 - 5 V	250 Ohm	0.25 V per mA	1.0 V
0 - 10 V	500 Ohm	0.5 V per mA	2.0 V

Table 19: Voltage Conversion for loop check with voltmeter

When no electrical load or high value resistor is used, the voltage between current loop (+) and (-) will nearly reach the voltage of the power supply (24 V).

Calculating the flow by the measured voltage:

$$\text{Flow [ml/min]} = \frac{(\text{Voltage [V]} - \text{Zero Point Voltage [V]})}{\text{Resistance}} \times 1000 \times \text{Conversion Factor (max. flow range)}$$

For more information regarding the conversion factor, see chapter 9.2 "[Flow Value and Coupling](#)".

Calculating the acoustic coupling RSS by the measured voltage:

$$\text{RSS [%]} = \frac{(\text{Voltage [V]} - \text{Zero Point Voltage [V]})}{0.016 \times \text{Resistance}} \times 100$$

## 14 Error Codes and Information

Description	Digital Interface RS-232 Error Byte "ee"	Display
No error	00	flow value RSS value
FLASH error during start-up test	01	error page w/01
FLASH error during runtime test	02	error page w/02
RAM error during runtime RAM test	08	error page w/08
Error in task handling	0F	error page w/0F
EEPROM test error (sensor)	19	error page w/19
Board temperature error (>75°C)	1A	error page w/1A
+15 V check error	1B	error page w/1B
-15 V check error	1C	error page w/1C
EEPROM CRC error (sensor)	21	error page w/21
EEPROM factor inconsistent (sensor)	22	error page w/22
EEPROM of the sensor not consistent (sensor)	27	error page w/27
Complementary values in EEPROM not equal (sensor)	29	error page w/29
Illegal sensor type or sensor version	2A	error page w/2A
Sensor parameter not correct	2B	error page w/2B
Wrong CRC in burst table	2E	error page w/2E

Table 20: Error Information on the Different Interfaces

## 15 Troubleshooting

If you experience any problems with the flow measurement system, please try the following solutions:

Problem	Possible Cause	Measure
<b>General</b>		
Unexpected change of RSS/ acoustic coupling value	Application parameters do not match the parameters of the selected calibration table.	<ol style="list-style-type: none"> <li>1. Check if the calibration parameters of your application (i.e. the medium, its temperature, the tube type) are the same ones the sensor was calibrated and adjusted for.</li> <li>2. Ensure that the parameters of the selected calibration table are the same ones you actually use in your current application.</li> </ol> <p>If the problem persists, please return the sensor and the BioProTT™ FlowTrack SL for servicing.</p>
on/off flow reading (togglng values)	Disturbance in the flow (e.g. small bubbles)	<ol style="list-style-type: none"> <li>1. Check if there are air bubbles in the tube.</li> <li>2. Remove the bubbles.</li> <li>3. Zero the system again.</li> </ol> <p>If the problem persists, please return the sensor and the BioProTT™ FlowTrack SL for servicing.</p>
No flow and RSS reading	<p>The sensor is not recognized.</p> <p><b>Please note:</b> BioProTT™ Clamp-On SLs with higher flow rates are only compatible with BioProTT™ FlowTrack SL devices with SW V3.0 and higher.</p>	<ol style="list-style-type: none"> <li>1. Check if the sensor is connected properly to the device and/or if the sensor is damaged.</li> <li>2. Check if there are any electromagnetic fields or disturbance sources that are not compliant with standards that could influence the sensor or if the sensor or its cable came into contact with an electric cautery.</li> <li>3. Remove the source of the electromagnetic field or carry the measurement out somewhere else.</li> </ol> <p>If the problem persists, please return the sensor and the BioProTT™ FlowTrack SL for servicing.</p>

Problem	Possible Cause	Measure
<b>General</b>		
Flow reading with no flow present	System may not have been zeroed.	<ol style="list-style-type: none"> <li>1. Zero the system.</li> <li>2. While doing so, ensure that the tube is filled completely but the liquid must not move.</li> </ol> <p>If the problem persists, please return the sensor and the BioProTT™ FlowTrack SL for servicing.</p>
BioProTT™ FlowTrack SL gets very warm	<p>The BioProTT™ FlowTrack SL might be exposed to an external heat source/ direct sunlight.</p> <p>The BioProTT™ FlowTrack SL might be covered so that heat cannot be dissipated.</p>	<ol style="list-style-type: none"> <li>1. Check if there is enough space around the BioProTT™ FlowTrack SL for the heat to dissipate.</li> <li>2. Ensure that the device is not exposed to direct heat and/or sunlight.</li> </ol> <p>If the problem persists, please return the sensor and the BioProTT™ FlowTrack SL for servicing.</p>
<b>Display</b>		
Display is blank frozen.	Power supply may be disconnected.	<ol style="list-style-type: none"> <li>1. Check if the device is connected to the power supply.</li> <li>2. Ensure that the connection is tight.</li> <li>3. Power the device off.</li> <li>4. Power the device on again.</li> </ol> <p>If the problem persists, please return the sensor and the BioProTT™ FlowTrack SL for servicing.</p>
Missing information/values on the screen	Display may have frozen.	<ol style="list-style-type: none"> <li>1. Refresh the screen by switching to another screen and back again.</li> <li>2. If no flow value is displayed, check if the coupling is within the specified range of &gt;50 %.</li> </ol> <p>If the problem persists, please return the sensor and the BioProTT™ FlowTrack SL for servicing.</p>

Problem	Possible Cause	Measures
<b>Digital Output</b>		
Erroneous offset on flow reading	Application parameters do not match the parameters the sensor was calibrated and adjusted for.	<ol style="list-style-type: none"> <li>1. Check if the calibration parameters of your application (i.e. the medium, its temperature, the tube type) are the same ones the sensor was calibrated and adjusted for.</li> <li>2. Ensure that the parameters of the selected calibration table are the same ones you actually use in your current application.</li> <li>3. Ensure that the system was zeroed.</li> <li>4. If necessary, zero again.</li> </ol> <p>If the problem persists, please return the sensor and the BioProTT™ FlowTrack SL for servicing.</p>
	System may not have been zeroed.	
No reading on digital interface	The sensor cable is damaged.	<ol style="list-style-type: none"> <li>1. Check if the sensor is connected properly to the device and if the sensor is damaged.</li> <li>2. Check if the cable is damaged.</li> <li>3. If the cable is damaged, please contact our service department.</li> </ol>
	Plug connector does not fit properly.	<ol style="list-style-type: none"> <li>1. Ensure that the right connector is used.</li> <li>2. If necessary, exchange the plug connector for the specified one.</li> <li>3. If there is any damage visible on either the plug connector or any other part of the cable or device, stop using it immediately and return the affected device for servicing.</li> </ol>
	Communication error.	<ol style="list-style-type: none"> <li>1. Check the connection between the computer and the device.</li> <li>2. Check if the correct UART port is used and if the settings (e.g. speed, number of bits, etc.) on the computer are the right ones (as described in <a href="#">chapter 10.1.3</a>).</li> </ol>

Problem	Possible Cause	Measures
<b>Digital Output</b>		
No reading on digital interface	Adapters are used without the correct driver.	<ol style="list-style-type: none"> <li>1. Ensure that the correct driver is used.</li> <li>2. If necessary, install the driver that is specified for the adapter.</li> </ol>
	The buffer of the serial communication has not been refreshed.	Refresh the buffer of the serial communication.
	Null modem cable is used.	Replace the cable with a simple (i.e. straight-through) serial cable.
	Wrong command is used.	<ol style="list-style-type: none"> <li>1. Check if the command used is the correct one for your needs.</li> <li>2. Use the correct command, refer to chapter 10.1.3 "<a href="#">Using the Digital Interface</a>" for more information.</li> </ol> <p>If the problem persists, please return the sensor and the BioProTT™ FlowTrack SL for servicing.</p>
<b>Analog Output—Flow Output</b>		
0 mA	<p>A reading of 0 mA could indicate:</p> <ul style="list-style-type: none"> <li>- a broken circuit</li> <li>- a missing power supply for the current loop</li> </ul>	<ol style="list-style-type: none"> <li>1. Check if the circuit is intact.</li> <li>2. In case of a broken circuit, fix the damage and try again.</li> <li>3. Ensure that the device is connected to the correct power supply.</li> <li>4. Ensure that the connection to the power supply is tight.</li> </ol> <p>If the problem persists, please return the sensor and the BioProTT™ FlowTrack SL for servicing.</p>



Problem	Possible Cause	Measures
<b>Analog Output –Flow Output</b>		
>0 to 1 mA	<p>A reading within this range could indicate:</p> <ul style="list-style-type: none"> <li>- insufficient coupling</li> <li>- that the sensor is not recognized</li> <li>- a circuit error</li> <li>- a device error</li> </ul>	<ol style="list-style-type: none"> <li>1. Ensure that the acoustic coupling is &gt;60%.</li> <li>2. Check if the correct sensor is connected and if it is not damaged.</li> <li>3. If the sensor is the correct type, disconnect it.</li> <li>4. Reconnect the sensor again.</li> <li>5. Ensure that the circuit is intact.</li> <li>6. If the circuit is broken, fix it and restart the measurement.</li> <li>7. Check if any errors are present and indicated on the display.</li> </ol> <p>If the problem persists, please return the sensor and the BioProTT™ FlowTrack SL for servicing.</p>
> 20 mA	<p>Flow value exceeds the specified range.</p> <p><b>Please note:</b> the flow range is limited to a maximum of approximately 23 mA</p>	<ol style="list-style-type: none"> <li>1. Ensure that the flow stays within the specified range.</li> <li>2. If necessary, adjust the pump setting.</li> </ol> <p>If the problem persists, despite the flow being within the specified range, please return the sensor and the BioProTT™ FlowTrack SL for servicing.</p>
<b>Analog Output –RSS Output</b>		
0 mA	<p>A reading of 0 mA could indicate:</p> <ul style="list-style-type: none"> <li>- a broken circuit</li> <li>- a missing power supply for the current loop</li> </ul>	<ol style="list-style-type: none"> <li>1. Ensure that the circuit is intact.</li> <li>2. If the circuit is broken, fix it and restart the measurement.</li> <li>3. Check if the device is connected to the power supply.</li> <li>4. Ensure that the connection is tight.</li> <li>5. Check if the power supply supplies the entire current loop.</li> <li>6. Power the device off.</li> <li>7. Power the device on again.</li> </ol> <p>If the problem persists, please return the sensor and the BioProTT™ FlowTrack SL for servicing.</p>

Problem	Possible Cause	Measures
<b>Analog Output –RSS Output</b>		
0 to 4 mA	<p>A reading within this range could indicate:</p> <ul style="list-style-type: none"> <li>- insufficient coupling</li> <li>- that the sensor is not recognized</li> <li>- a circuit error</li> <li>- a device error</li> </ul>	<ol style="list-style-type: none"> <li>1. Ensure that the acoustic coupling is &gt;50 %.</li> <li>2. Check if the correct sensor is connected and if it is not damaged.</li> <li>3. If the sensor is the correct type, disconnect it.</li> <li>4. Reconnect the sensor again.</li> <li>5. Ensure that the circuit is intact.</li> <li>6. If the circuit is broken, fix it and restart the measurement.</li> <li>7. Check if any errors are present and indicated on the display.</li> </ol> <p>If the problem persists, please return the sensor and the BioProTT™ FlowTrack SL for servicing.</p>

Table 21: Troubleshooting



- The maximum flow range depends on the BioProTT™ Clamp-On SL.
- Please check if the BioProTT™ Clamp-On SL is suitable for the flow range you need for your application.

## 16 Environmental Protection and Disposal

### Packaging

Packaging materials are made from environmentally friendly materials. The packaging materials will be disposed of by em-tec GmbH upon request.

### Disposal

The BioProTT™ FlowTrack SL and its accessories must be disposed of in accordance with the applicable national provisions for electronic components. In accordance with the requirements of EU Directive **2012/65/EC** Waste Electrical and Electronic Equipment (WEEE), our customers in the EU are entitled to return all waste deriving from the products to us – in clean and disinfected condition. The em-tec GmbH WEEE registration number is: **DE 99135207**.

Upon receipt, we repair or dispose of these components properly. For our address please see the very beginning of this user manual. For the best utilization of raw materials, the product and its components and accessories should not be disposed of together with household waste. All parts must be collected separately from household waste and disposed of in an environmentally responsible way in accordance to local regulations.

- Before disposal, decontaminate all parts according to the procedure applicable in the clinic.
- If you have questions about disposal, please contact em-tec GmbH's service department.
- Waste may only be brought to the appropriate recycling facility if there is no risk of potential infection from electrical and electronic waste.

## 17 Technical Specifications of the BioProTT™ FlowTrack SL

Size (HxWxD), weight	65 x 110 x 140 mm, approx. 500 g
Housing material	aluminum
IP-Code	IP 65 (with attached protection caps; protected against dust and high pressure water jets/wash down from all directions)
Supply voltage	24 V DC (± 10%) via power adapter or external supply
Power consumption	typically 3 W. max. 8 W
Power supply	wall power supply with connectors of the type EURO, UK, US/Japan, Australia, and IEC 60320 C8; others available upon request
Expected Product Life	10 years

### Interfaces and Graphical User Interface (GUI)

Interface Types	RS-232/4-20 mA analog output: Flow and Received Signal Strength (RSS)
Graphical User Interface (GUI)	Graphical user interface to select calibration table and to view real-time data. Totalizing feature accessible. The mean flow value (1 Hz) is displayed with a 1 s refresh rate.

### Functions

Zeroing	via push button and digital interface
Adjustment and calibration	Adaptable with integrated calibration factor
Output	digital [0.1 Hz, 1 Hz, 10 Hz]

### Ambient Conditions

Air Pressure	70 kPa to 106 kPa
Operating temperature range	10 °C to 40 °C (50 °F to 104 ° F)
Storage temperature range	-20 °C to 45 °C (-4 °F to 113 ° F)
Transport temperature range	-20 °C to 55 °C (-4 °F to 131 ° F)
Relative Humidity during transport, storage, and operation	10 % to 96% (non-condensing)

## About em-tec GmbH

em-tec has been a specialist for flow measurement systems in the medical and bioprocessing technology sector for over 30 years. The company's core competence is the non-invasive flow measurement using the ultrasonic transit-time method, that is used for applications in extracorporeal circulation systems of life-sustaining systems as well as in biopharma applications that use flexible tubes. Headquartered in Finning, Germany, em-tec is part of PSG®, a Dover company.

For more information about em-tec, please visit [em-tec.de](http://em-tec.de). For more information about PSG®, please visit [psgdover.com](http://psgdover.com).

## About Dover

Dover is a diversified global manufacturer and solutions provider with annual revenue of approximately \$7 billion. We deliver innovative equipment and components, consumable supplies, aftermarket parts, software and digital solutions, and support services through five operating segments: Engineered Products, Fueling Solutions, Imaging & Identification, Pumps & Process Solutions and Refrigeration & Food Equipment. Dover combines global scale with operational agility to lead the markets we serve. Recognized for our entrepreneurial approach for over 60 years, our team of over 23,000 employees takes an ownership mindset, collaborating with customers to redefine what's possible. Headquartered in Downers Grove, Illinois, Dover trades on the New York Stock Exchange under "DOV." Additional information is available at [dovercorporation.com](http://dovercorporation.com).



